

PROMOTION  
**2020**

**DOGHER**  
*Making Solutions* <sup>®</sup> **TOOLS**



**INDUSTRIAL QUALITY**  
**MAXIMUM PERFORMANCE**

RECOMMENDED RETAIL PRICES - EXCLUDING VAT



**TOOL CABINET  
7 DRAWERS**



**Monza**

Ref 025-014  
~~1.019,11 €~~ **554,51 €**

**TOOL CABINET  
5 DRAWERS**



**Suzuka**

Ref 025-016  
~~926,47 €~~ **504,11 €**

**TOOL CABINET  
6 DRAWERS**



**Silverstone**

Ref 025-015  
~~986,94 €~~ **537,01 €**



Fast Lock/Unlock  
function drawers



Safety Central  
Locking



Long Life Casters  
and safety Brakes



Reinforced plastic  
protection around the edges



10 x10 mm  
38 x38 mm Perforated side  
panel



Max. Load for each  
drawer: 40 - 45 Kg

Dimensions F1 range

Tool Cabinet: 678 x 459 x 1.000 mm Drawers: 568 x 398 x 75 mm · 568 x 398 x 154 mm

**TOOL CABINET  
7 DRAWERS**



**Jerez**

Ref 025-017  
~~881,64 €~~ **492,68 €**

**TOOL CABINET  
5 DRAWERS**



**Assen**

Ref 025-018  
~~834,65 €~~ **454,15 €**

Dimensions GP range

Tool Cabinet: 678 x 459 x 1.000 mm Drawers: 568 x 398 x 75 mm · 568 x 398 x 154 mm



Fast lock/Unlock  
function drawers



Safety central locking



Long life casters and  
safety brakes



Reinforced plastic  
protection around  
the edges



38 x38 mm  
Perforated side  
panel



Max. Load for each  
drawer: 30 - 35 Kg

**TOOL CABINET**

+ TOOLS



Ref 025-016

**TOOL CABINET**

+ TOOLS



Ref 025-018

**TOOL CABINET**

+ TOOLS



Ref 025-007

**TOOL CABINET +150 TOOLS**

Ref 025-551

~~1.616,21 €~~ **863,32 €**

**TOOL CABINET +150 TOOLS**

Ref 025-550

~~1.524,39 €~~ **813,85 €**

**TOOL CABINET +150 TOOLS**

Ref 025-567

~~1.293,66 €~~ **707,14 €**

**TOOL CABINET +211 TOOLS**

Ref 025-561

~~1.764,70 €~~ **941,80 €**

**TOOL CABINET +211 TOOLS**

Ref 025-560

~~1.672,88 €~~ **892,90 €**

**TOOL CABINET +211 TOOLS**

Ref 025-557

~~1.442,15 €~~ **770,10 €**

**COMPOSITION 150 TOOLS**

205-080 · 330-080 · 451-080 · 450-080



Eva Foam Trays 1/4 (375 x 140 x 30 mm)

Content:

- ▶ Ref 205-080: 4 Professional Pliers
- ▶ Ref 330-080: 5 Professional Screwdrivers
- ▶ Ref 451-080: 8 Combination Wrenches
- ▶ Ref 450-080: 8 Double Open Ended Wrenches

840-080



Eva Foam Trays 1 (375 x 560 x 30 mm)

Content:

- ▶ Ref 840-080: Multitools



94 Pieces Case  
Check Content p. 39

- ▶ Ref 500-030: 1/4" & 1/2" Sockets

**COMPOSITION 211 TOOLS**

205-080 · 330-080 · 451-080 · 450-080

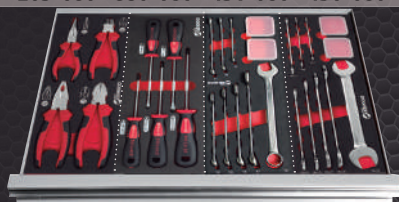

Eva Foam Trays 1/4

(375 x 140 x 30 mm) Content:

- ▶ Ref 205-080: 4 Professional Pliers
- ▶ Ref 330-080: 5 Professional Screwdrivers
- ▶ Ref 451-080: 8 Combination Wrenches
- ▶ Ref 450-080: 8 Double Open Ended Wrenches

840-080



Eva Foam Trays 1

(375 x 560 x 30 mm) Content:

- ▶ Ref 840-080: Multitools

500-084



Eva Foam Trays 1

(375 x 560 x 30 mm) Content:

- ▶ Ref 500-084: Multitools

## TOOL CABINET 3 DRAWERS



- 300 kg Max. Load for Tool Cabinet
- 30-35 kg Max. Load for each Drawer

• 570 x 410 mm Drawer Dim.:

- Bottom storage with separated safety lock

458 mm  
995 mm  
680 mm

Ref 025-008  
~~702,46 €~~ 402,88 €

## TOOL CABINET 5 DRAWERS



- 320 kg Max. Load for Tool Cabinet
- 30-35 kg Max. Load for each Drawer

• 568 x 398 mm Drawer Dim.:

459 mm  
1000 mm  
678 mm

Ref 025-007  
~~603,92 €~~ 346,37 €

## TOOL CABINET 7 DRAWERS



- 320 kg Max. Load for Tool Cabinet
- 30-35 kg Max. Load for each Drawer

459 mm  
1000 mm  
678 mm

• 568 x 398 mm Drawer Dim.:

Ref 025-005  
~~757,79 €~~ 423,47 €

- 7 Drawers with anti-slip rubber protection

## TOOL CABINET 7 DRAWERS



Ref 025-012  
~~1.173,60 €~~ 664,46 €



### MAXIMUM PERFORMANCE

- Top plate with tool keeper and compartments for small pieces and tools
- Integrated side/lateral tool-keeper
- Folding Tray
- Lateral/Side Metal Handle for easy transport
- High resistance Casters
- Long durability
- Wheel locking system
- 4 bottom corner protections for hit absorption



### BLOCKING AND SAFETY

- Press the tab to open the drawers

- 340 kg Max. Load for Tool Cabinet
- 30-35 kg Max. Load for each Drawer
- 570 x 410 mm Drawer Dim.

## METAL TROLLEY

### MAXIMUM PERFORMANCE:

- Perforated side pannel
- Long Life Casters
- 2 Driving wheels with brakes

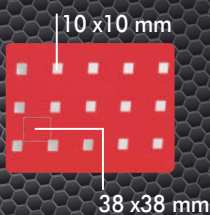

Tool Cabinet: 705 x 390 x 675 mm

Max. Total Load: 150 kg  
Max. load per tray: 50 kg

## TROLLEY 3 FLOORS



Ref 025-028

~~255,55 €~~ 150,32 €

## TROLLEY 3 FLOORS & 1 DRAWER



- Includes a Drawer

Ref 025-029

~~387,56 €~~ 227,98 €



## METAL WORK BENCH WITH TOOL-KEEPER BOARD 2 DRAWERS

- Tool-Keeper Board

1500 x 730 mm

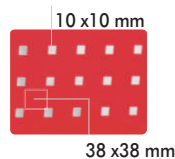

- 2 High Capacity Drawers

Max. Load: 900 kg  
Bench: 1500 x 640 x 1550 mm

Ref 027-004

~~1.074,01 €~~ 576,49 €

## METAL WORK BENCH 3 DRAWERS

- 3 High Capacity Drawers

Max. Load: 500 kg  
Bench: 2000 x 640 x 865 mm



Ref 027-001

~~1.036,07 €~~ 609,45 €

# DRAWER COMPOSITIONS

## FOR TOOL CABINETS DOGHER TOOLS



DESCRIPTIVE LABEL FOR A QUICK SEARCH

### 238 SELECTED TOOLS

#### ASSORTMENT OF 6 DRAWERS

Ref 025-504

~~2.631,87 €~~ 1.452,85 €

\* Tool Cabinet not included

#### ▶ DRAWER 1

220X-080 · 205-080 · 225-080 · 276-080



#### ▶ DRAWER 2

300-081 · 330-081 · 351-081 · 360-080

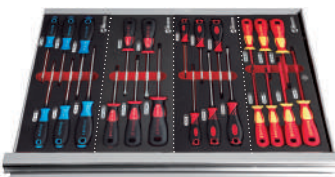

#### ▶ DRAWER 3

450-080 · 451-080 · 460-080 · 491-080

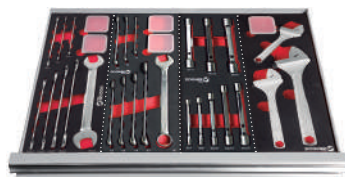

### 218 SELECTED TOOLS

#### ASSORTMENT OF 5 DRAWERS

Ref 025-503

~~2.480,00 €~~ 1.363,52 €

\* Tool Cabinet not included

#### ▶ DRAWER 1

451-081 · 450-081 · 457-080



#### ▶ DRAWER 2

220X-080 · 205-080 · 491-080 · 330-080



#### ▶ DRAWER 3

840-080



### 148 SELECTED TOOLS

#### ASSORTMENT OF 5 DRAWERS

Ref 025-505

~~1.905,60 €~~ 1.081,28 €

\* Tool Cabinet not included

#### ▶ DRAWER 1

451-081 · 450-081 · 457-080



#### ▶ DRAWER 2

220X-080 · 250-080 · 491-080 · 276-080



#### ▶ DRAWER 3

840-080



### 162 SELECTED TOOLS

#### ASSORTMENT OF 4 DRAWERS

Ref 025-501

~~1.918,60 €~~ 1.058,67 €

\* Tool Cabinet not included

#### ▶ DRAWER 1

220X-080 · 205-080 · 225-080 · 276-080



#### ▶ DRAWER 2

330-084 · 729-080 · 623-080



#### ▶ DRAWER 3

450-080 · 451-080 · 460-080 · 493-080



### 123 SELECTED TOOLS

#### ASSORTMENT OF 4 DRAWERS

Ref 025-500

~~1.651,12 €~~ 931,59 €

\* Tool Cabinet not included

#### ▶ DRAWER 1

451-081 · 450-081 · 457-080



#### ▶ DRAWER 2

330-084 · 729-080 · 623-080



#### ▶ DRAWER 3

220X-080 · 205-080 · 491-080 · 276-080



### 106 SELECTED TOOLS

#### ASSORTMENT OF 3 DRAWERS

Ref 025-502

~~1.104,33 €~~ 609,94 €

\* Tool Cabinet not included

#### ▶ DRAWER 1

220X-080 · 451-080 · 450-080 · 491-080

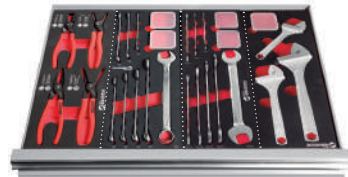

#### ▶ DRAWER 2

330-080 · 205-080 · 501-080

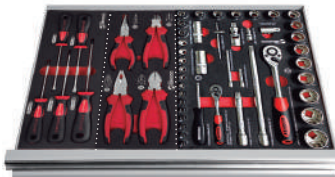

#### ▶ DRAWER 3

840-080



\* Check contents of EVA Foam Trays in DOGHER TOOLS Promotion from page 8 to page 13.



**HIGH DENSITY FOAM FOR AN EASY PLACEMENT OF THE TOOLS**

► DRAWER 4

840-080



► DRAWER 5

501-080 · 618-080

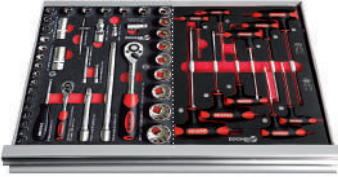

► DRAWER 6

534-080 · 538-080 · 502-080 · 503-080



► DRAWER 4

501-080 · 618-080



► DRAWER 5

534-080 · 538-080 · 502-080 · 503-080



► DRAWER 4

501-080 · 618-080

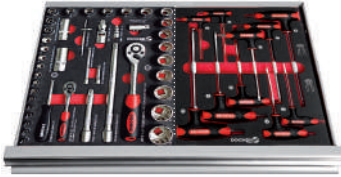

► DRAWER 5

330-084 · 205-081 · 623-080



► DRAWER 4

501-080 · 516-080 · 534-080

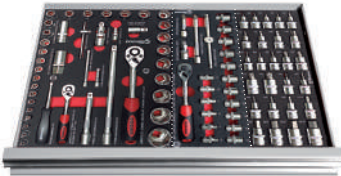

► DRAWER 4

501-080 · 618-080

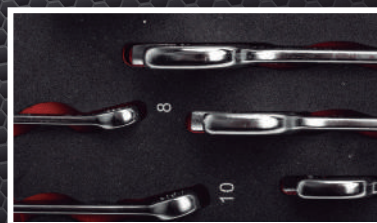
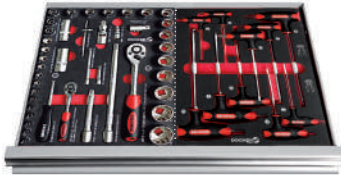

**4 HIGH LEVERAGE****PLIERS**

160 mm

200 mm



180 mm

160 mm



Ref 200-080

~~128,81 €~~**75,77 €****4 PROFESSIONAL****PLIERS**

160 mm

160 mm



180 mm

180 mm



Ref 205-080

~~83,46 €~~**49,09 €****3 INSULATED****PLIERS 1000V**

160 mm



180 mm

160 mm



Ref 250-080

~~98,40 €~~**57,88 €****8 DOUBLE OPEN ENDED****WRENCHES**

6x7 · 8x9 · 10x11 · 12x13

14x15 · 16x17 · 18x19 · 20x22



Ref 450-080

~~61,94 €~~**36,44 €****8 DOUBLE ENDED HEX SOCKET****WRENCHES**

6x7 · 8x9 · 10x11 · 12x13

14x15 · 16x17 · 18x19 · 20x22



Ref 460-080

~~147,30 €~~**86,65 €****EVA FOAM TRAYS FOR TOOL CABINETS****1/2**Dimensions 1/2:  
375 x 280 x 30 mm**1/3**Dimensions 1/3:  
375 x 188 x 30 mm**1/4**Dimensions 1/4:  
375 x 140 x 30 mm**4 CIRCLIP®****PLIERS**

180 mm

180 mm



180 mm

180 mm



Ref 220-080

~~98,50 €~~**53,24 €****4 CIRCLIP®****PLIERS PRO**

180 mm

180 mm



180 mm

180 mm



Ref 220X-080

~~100,32 €~~**59,01 €****4 PROFESSIONAL****MINI-PLIERS**

125 mm

125 mm



125 mm

125 mm



Ref 225-080

~~66,35 €~~**39,03 €****4 ESD****MINI-PLIERS**

125 mm

125 mm



125 mm

125 mm



Ref 237-080

~~72,65 €~~**42,74 €****8 DOUBLE RING FLAT****WRENCHES**

6x7 · 8x9 · 10x11 · 12x13

14x15 · 16x17 · 18x19 · 20x22



Ref 454-080

~~91,25 €~~**53,68 €****3 PROFESSIONAL ADJUSTABLE****WRENCHES**

150mm · 200mm · 250mm



Ref 493-080

~~75,06 €~~**44,15 €**



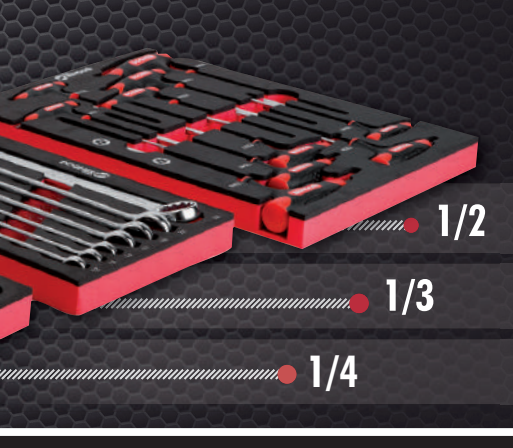

1/2

1/3

1/4

## 6 INDUSTRIAL PLUS SCREWDRIVERS

Milled  
3 · 4 · 5 · 6

PH1 · PH2

Ref 300-080

~~54,43 €~~ 32,02 €

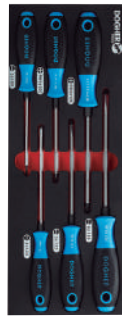

## 6 INDUSTRIAL PLUS SCREWDRIVERS

Milled  
3 · 4 · 5 · 6

PZ1 · PZ2

Ref 300-081

~~54,43 €~~ 32,02 €



## 6 INDUSTRIAL PLUS SCREWDRIVERS

T10 · T15 · T20  
T25 · T30 · T40

Ref 303-080

~~49,59 €~~ 29,17 €



## 5 INDUSTRIAL SCREWDRIVERS

Milled  
5,5 · 6,5

PH1 · PH2 · PH3

Ref 315-080

~~43,96 €~~ 25,86 €



## 5 INDUSTRIAL SCREWDRIVERS

Milled  
5,5 · 6,5

PZ1 · PZ2 · PZ3

Ref 315-081

~~43,01 €~~ 25,30 €



## 5 PROFESSIONAL SCREWDRIVERS

Stamped  
5,5 · 6,5

PH1 · PH2 · PH3

Ref 330-080

~~38,01 €~~ 22,36 €



## 5 PROFESSIONAL SCREWDRIVERS

Stamped  
5,5 · 6,5

PZ1 · PZ2 · PZ3

Ref 330-081

~~39,51 €~~ 23,24 €



## 6 ANTI-SLIP SCREWDRIVERS

Milled  
3 · 4 · 5,5 · 6,5

PH1 · PH2

Ref 351-080

~~45,39 €~~ 26,70 €



## 6 ANTI-SLIP SCREWDRIVERS

Recta  
3 · 4 · 5,5 · 6,5

PZ1 · PZ2

Ref 351-081

~~46,58 €~~ 27,40 €



## 7 INSULATED SCREWDRIVERS 1000V



Recta  
3 · 4 · 5,5 · 6,5

PH0 · PH1 · PH2

Ref 360-080

~~65,52 €~~ 38,54 €

TESTED



## 7 INSULATED SCREWDRIVERS 1000V



Recta  
3 · 4 · 5,5 · 6,5

PZ0 · PZ1 · PZ2

Ref 360-081

~~66,02 €~~ 38,84 €

TESTED



## 3 LOCKING PLIERS



125mm · 175mm · 250mm

Ref 276-080

~~67,95 €~~ 39,97 €



## 2 HAMMERS

320g Carpenter Hammer  
Ref 702-320

Ø 35 Rubber Hammer  
Ref 731-35

Ref 700-080

~~36,18 €~~ 21,28 €



**26** PIECES**1/2" SOCKET BITS**

1/2"

- 4 · 5 · 6 · 7 · 8 · 10  
12 · 14 · 17 · 19
- T20 · T25 · T27 · T30  
T40 · T45 · T50 · T55 · T60
- 5 · 6 · 8 · 10 · 12 · 14 · 16

Ref 534-080

~~316,13 €~~ **167,36 €****12** PIECES**1/2" DEEP SERIES SOCKET BITS**

1/2"

- 100 mm: 5 · 6 · 7 · 8 · 12  
140 mm: 5 · 10
- 120 mm: T40 · T55
- 100 mm: 8 · 10 · 12

Ref 538-080

~~195,57 €~~ **103,54 €****18** Pieces**1/4", 3/8" & 1/2" DEEP SERIES SOCKETS**

1/4"

4 · 5 · 6 · 7 · 8 · 9 · 10

3/8"

10 · 11 · 12 · 13 · 14 · 15

1/2"

16 · 17 · 18 · 19 · 22

Ref 502-080

~~183,24 €~~ **97,01 €****29** PIECES**1/4" & 1/2" TORX SOCKETS**

1/2"

- E10 · E11 · E12 · E14 · E16  
E18 · E20 · E22 · E24
- TS20 · TS25 · TS27 · TS30  
TS40 · TS45 · TS50 · TS55 · TS60

1/4"

- E4 · E5 · E6 · E7 · E8
- T6 · T7 · T8 · T9 · T10 · T15

Ref 503-080

~~250,96 €~~ **132,86 €****22** PIECES**3/8" HEXAGONAL**

3/8"

6 · 7 · 8 · 9 · 10 · 11 · 12 · 13 · 14  
15 · 16 · 17 · 18 · 19 · 20 · 21 · 22

- 72 Teeth Ratchet Handle
- Universal Joint
- Extensions: 50 & 100mm
- Sliding "T" Handle

Ref 516-080

~~198,16 €~~ **104,91 €****3** ORGANIZERS

Ref 010-080

~~27,05 €~~ **15,91 €****46** PIECES**1/4" HEXAGONAL OR BIHEXAGONAL SOCKETS**

1/4"

4 · 4,5 · 5 · 5,5 · 6 · 7 · 8 · 9 · 10 · 11 · 12 · 13 · 14  
Long Series: 6 · 7 · 8 · 9 · 10 · 11 · 12 · 13 · 14

- HX3 · HX4 · HX5 · HX6 · HX7 · HX8
- PH1 · PH2 · PH3    PZ1 · PZ2
- T10 · T15 · T20 · T25 · T30 · T40

- 72 Teeth Ratchet Handle
- Universal Joint
- Extensions: 50 & 100mm
- 145mm Flexible Extension
- Spinner Handle
- Sliding "T" Handle

Hexagonal Ref 500-081 ~~323,72 €~~ **171,38 €**Bi-hexagonal Ref 501-081 ~~323,72 €~~ **171,38 €****3** ELECTRICIAN TOOLSElectrician Scissors with Stripping Notch  
Ref. 296-003Terminal Crimping Tool  
Ref 296-056Automatic Wire Stripper  
Ref 296-051

Ref 296-080

~~61,77 €~~ **36,34 €****4** INSULATED PLIERS 1000V

240 mm

160 mm

160 mm

180 mm



Ref 250-081

~~142,61 €~~ **83,89 €****4** PROFESSIONAL PLIERS

160 mm

250 mm

180 mm

160 mm



Ref 205-081

~~102,53 €~~ **60,31 €**

## 10 SCREWDRIVERS

### INSULATED 1000V & PROFESSIONAL

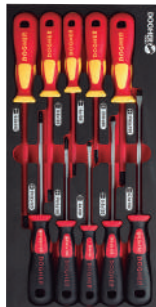

-  Milled  
4 · 5,5 · 6,5
-  PH1 · PH2
-  Stamped  
4 · 5,5 · 6,5
-  PH1 · PH2



 Ref 330-084  
~~83,57 €~~ **49,16 €**

## 7 PROFESSIONAL

### SCREWDRIVERS

-  Milled  
3 · 4 · 5,5 · 6,5
-  PH0 · PH1 · PH2



 Ref 330-082  
~~45,61 €~~ **26,83 €**

## 7 PROFESSIONAL

### SCREWDRIVERS

-  Milled  
3 · 4 · 5,5 · 6,5
-  PZ0 · PZ1 · PZ2

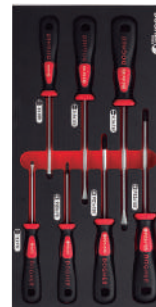

 Ref 330-083  
~~46,89 €~~ **27,58 €**

## 10 DOUBLE OPEN ENDED

### WRENCHES



6x7 · 8x9 · 10x11 · 12x13  
14x15 · 16x17 · 18x19  
20x22 · 21x23 · 24x26



 Ref 450-081  
~~90,86 €~~ **53,45 €**

## 3 DOUBLE OPEN ENDED

### WRENCHES



25x28 · 27x29 · 30x32



 Ref 450-082  
~~65,90 €~~ **38,76 €**

## 10 COMBINATION

### WRENCHES



8 · 10 · 11 · 12 · 13  
14 · 17 · 19 · 22 · 24



 Ref 451-081  
~~118,60 €~~ **69,77 €**

## 3 COMBINATION

### WRENCHES



27 · 30 · 32



 Ref 451-083  
~~94,94 €~~ **55,85 €**

## 6 DOUBLE RING

### WRENCHES



75°  
8x9 · 10x11 · 12x13  
14x15 · 16x17 · 18x19



 Ref 453-080  
~~85,60 €~~ **50,35 €**

## 9 PIECES

### 6 DOUBLE BOX 15° GEAR WRENCHES 3 SQUARE DRIVES

 1/4" · 3/8" · 1/2"

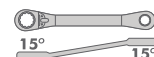

15°  
8x9 · 10x11 · 12x13  
14x15 · 16x18 · 17x19



 Ref 455-080  
~~246,68 €~~ **145,11 €**

## 10 PIECES

### 7 COMBINATION GEAR WRENCHES 3 SQUARE DRIVES



 1/4" · 3/8" · 1/2"



 15°  
10 · 12 · 13  
14 · 15 · 17 · 19



 Ref 457-080  
~~232,20 €~~ **136,59 €**

## 6 DOUBLE FLEXIBLE SOCKET

### WRENCHES



8x9 · 10x11 · 12x13  
14x15 · 16x17 · 18x19



 Ref 467-080  
~~144,22 €~~ **82,72 €**

### 36 PIECES

#### 1/4" HEXAGONAL SOCKETS

- Folding Key Set: 1,5 · 2 · 2,5 · 3 · 4 · 5 · 6 · 8
- 5,5 · 6 · 7 · 8 · 9 · 10 · 11 · 12 · 13 Long Series: 6 · 8 · 10 · 12 · 13
- PH1 · PH2 · PH3 PZ1 · PZ2 · PZ3
- HX3 · HX4 · HX5 · HX6 · HX7
- 4 · 5,5 · 6,5

- 72 Teeth Ratchet Handle
- Universal Joint
- Extensions: 50 & 100mm
- Sliding "T" Handle
- Spinner Handle
- Palm Driver



Ref 500-083  
~~267,99 €~~ 141,88 €

### 27 PIECES

#### 1/2" HEXAGONAL OR BIHEXAGONAL SOCKETS

- 8 · 9 · 10 · 11 · 12 · 13 · 14 · 15 · 16 · 17 · 18 · 19 · 20 · 21 · 22 · 23 · 24 · 27 · 30 · 32
- Spark Plug: 16 · 21

- 72 Teeth Ratchet Handle
- Universal Joint 3/8" 1/2"
- Extensions: 125 & 250mm
- Universal Joint

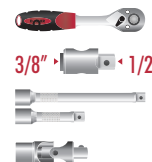

Hexagonal Ref 531-080 ~~270,56 €~~ 143,24 €  
 Bi-hexagonal Ref 530-080 ~~270,56 €~~ 143,24 €



### 25 PIECES

#### 1/2" IMPACT SERIES SOCKETS

- 8 · 9 · 10 · 11 · 12 · 13 · 14 · 15 · 16 · 17 · 18 · 20 · 21 · 22 · 24
- Long Series: 17 · 19 · 21 · 22 · 24
- Colour Impact Sockets: 17 · 19 · 21

- Impact Universal Joint
- Extension: 125 mm

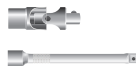

Ref 570-080  
~~381,95 €~~ 202,21 €

### 23 PIECES

#### 1/2" IMPACT SERIES SOCKETS

- E10 · E12 · E14 · E16 · E18 · E20 · E24
- T25 · T27 · T30 · T40 · T45 · T50 · T55 · T60
- 5 · 6 · 8 · 10 · 12 · 14 · 17 · 19

Ref 572-080  
~~437,53 €~~ 231,63 €



### 7 PIECES

#### 3 WAY T-TYPE SLIDING HEX KEY WRENCH

- 2 · 2,5 · 3 · 4 · 5 · 6 · 8

Ref 623-080  
~~140,50 €~~ 82,65 €



### 9 PIECES

#### PERCUSSION

- Rivoir French Style Hammers Fiberglass Handle 35 mm
- Long Drift Punch 3x10mm
- Long Drift Punch 4x10mm
- Long Drift Punch 5x10mm
- Long Drift Punch 6x10mm
- Long Drift Punch 8x12mm
- Long Drift Punch 10x12mm
- Rubber Hammer Fiberglass Handle 35 mm
- Cold Chisel 13x23x30x250 mm

Ref 729-080  
~~110,61 €~~ 65,07 €



### 8 CIRCLIP®

#### PLIERS PRO

- 140 / 180 mm
- 140 / 180 mm
- 140 / 180 mm
- 140 / 180 mm

Ref 220X-081  
~~197,34 €~~ 116,08 €



### 11 6X6 ANGLED

#### OPEN SOCKET WRENCHES

- 8 · 10 · 11 · 12 · 13 · 14 · 15 · 16 · 17 · 18 · 19

Ref 462-080  
~~188,62 €~~ 110,95 €



# 43 PIECES

## 1/4" & 1/2" HEXAGONAL OR BIHEXAGONAL SOCKETS

**1/2"** 10 · 11 · 12 · 13 · 14 · 15 · 16 · 17 · 18 · 19 · 20 · 21  
22 · 24 · 27 · 30 · 32 Spark Plug: 16 · 21

**1/4"** 4 · 4,5 · 5 · 5,5 · 6 · 7 · 8  
9 · 10 · 11 · 12 · 13 · 14

72 Teeth Ratchet Handle



72 Teeth Ratchet Handle



3-Way Adapter



Extensions: 50 & 100mm



Extensions: 125 & 250mm



Universal Joint



Universal Joint



Spinner Handle



Sliding "T" Handle



Hexagonal Ref 500-080 ~~385,29 €~~ **186,98 €**  
Bi-hexagonal Ref 501-080 ~~385,29 €~~ **186,98 €**



# 10 BALL NOSE HEX T-HANDLE

2 · 2,5 · 3 · 4 · 5 · 6 · 7 · 8 · 10 · 12

Ref 618-080  
~~132,01 €~~ **77,65 €**



Ref 617-080  
~~132,01 €~~ **77,65 €**

# 10 HEX T-HANDLE

2 · 2,5 · 3 · 4 · 5 · 6 · 7 · 8 · 10 · 12

# 10 TORX TAMPER T-HANDLE

TS9 · TS10 · TS15 · TS20 · TS25 · TS27 · TS30 · TS40 · TS45 · TS50

Ref 620-080  
~~111,67 €~~ **65,69 €**

# 155 PCS MULTITOOLS

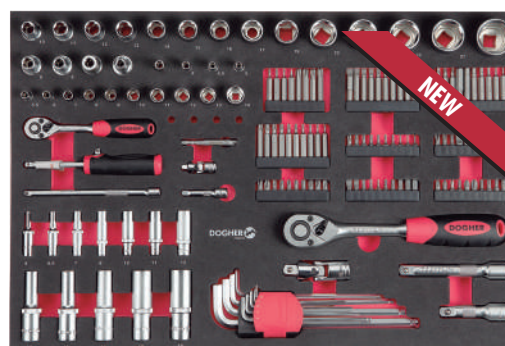

Ratched Handle 72 teeth (510-001)

Extensions 150 mm (509-007) 50 mm (509-006)

Universal Joint (509-009)

4 · 4,5 · 5 · 5,5 · 6 · 7 · 8 · 9 · 10 · 11 · 12 · 13 · 14

Spinner Handle (509-017) 1/4"

Hexagonal Shank Socket Adaptor 1/4" 1/4" (509-019)

Square Drive Bit Holders 1/4" 1/4" (509-012)

4 · 5 · 5,5 · 6 · 7 · 8 · 10 · 11 · 13

# 31 PIECES MIXED



- Rubber Hammer Threaded Head Hickory Handle Dead Blow 35 mm
- Ball Pen Hammers Hickory Handle 455 grs.
- Magnetic Measuring Tape 3 m
- Screw Locking Knife Cutter 18 mm
- Bi-material Handle Flat File 2nd Cut 200 mm
- Bi-material Handle Flat File Bastard Cut 200 mm
- Professional Electrician Scissors 145 mm
- Key Wrench Set Extra Long Ball Nose Hex 9 pieces 1,5-10
- 10 Bi-Metal Hacksaw Blades 300x13x0,65
- Hacksaw Frame 300 mm
- Long Drift Punch 4x10 mm
- Long Drift Punch 5x10 mm
- Long Drift Punch 6x10 mm
- Button Quick Release Water Pump Plier 240 mm

Ref 840-080  
~~247,61 €~~ **145,65 €**

Ratched Handle 72 teeth (544-001)

Extensions 125 mm (543-003) 75 mm (543-002)

Universal Joint (543-009)

9 Pcs (605-009)

Key Wrench Set Extra Long Ball Nose Hex 1,5-2 · 2,5 · 3 · 4 · 5 · 6 · 8 · 10 mm

1/4" Screwdriver Bits 1/4" · 25 mm

PH0 · PH1 · PH2 · PH3 · PH4  
PZ0 · PZ1 · PZ2 · PZ3 · PZ4  
3 · 3,5 · 4 · 4,5 · 5 · 5,5 · 6 · 6,5 · 8  
T5 · T6 · T7 · T8 · T9 · T10 · T15 · T20 · T25 · T27 · T30 · T40

1/4" Screwdriver Bits 1/4" · 50 mm

PH1 · PH2 · PH3 · PH4  
PZ1 · PZ2 · PZ3 · PZ4  
3 · 3,5 · 4 · 4,5 · 5 · 5,5 · 6 · 6,5 · 8  
HX1,5 · HX2 · HX2,5 · HX3  
HX4 · HX5 · HX6 · HX8 · HX10  
R1 · R2 · R3  
TS10 · TS15 · TS20  
TS25 · TS27 · TS30 · TS40

Ref 500-084  
~~325,26 €~~ **191,33 €**

5/16" Screwdriver Bits 5/16" · 30 mm  
T40 · T45 · T50 · T55

## MAXIMUM PERFORMANCE

- 3 removable modules
- 1 tool box
- 2 high capacity drawers
- 1 folding chest

## INTERMODULE COUPLINGS

Stronger, avoids uncomfortable oscillations

## SAFETY LOCKS

Double Metal Safety Lock

## PADLOCK CLOSING POSSIBILITY

**SOLUTIONS  
3 IN 1**

Ref 051-002

~~270,11 €~~ **158,89 €**

490 x 300 x 720 mm

## 3 FLOOR TROLLEY

+47 TOOLS



300 mm  
720 mm  
490 mm

**27**  
Pcs

1/2"



(531-080)

8 · 9 · 10 · 11 · 12 · 13 · 14 · 15 · 16 · 17  
18 · 19 · 20 · 21 · 22 · 23 · 24 · 27 · 30 · 32

250 mm  
125 mm

3/8" · 1/2" (524-021)

16 · 21

**10**  
Pcs



(450-081)



6x7 · 8x9 · 10x11 · 12x13 · 14x15  
16x17 · 18x19 · 20x22 · 21x23 · 24x26

**10**  
Pcs



(330-084)

TESTED

4 · 5,5 · 6,5 PH1 · PH2

4 · 5,5 · 6,5 PH1 · PH2

Ref 051-500

~~715,10 €~~ **400,68€**

## METAL TROLLEY

COMPACT - 2 DRAWERS + FOLDING CHEST

- 1 Tool box with portable tray inside
- 2 drawers
- 1 High capacity folding chest
- Removable telescopic rear handle

SAFETY LOCKS  
Double Metal Safety Lock



265 mm  
550 mm  
410 mm

Ref 051-008

~~162,50 €~~ **95,59 €**

## METAL TROLLEY

COMPACT - 4 DRAWERS

- 1 Tool box with portable tray inside
- 4 drawers (2 High capacity drawers)
- Removable telescopic rear handle

SAFETY LOCKS  
Double Metal Safety Lock



265 mm  
550 mm  
410 mm

Ref 051-009

~~187,50 €~~ **110,29 €**

**TROLLEY**  
**3 MODULES**



- 1 Folding Chest
- 1 Tool Box
- 3 High Capacity Drawers
- High Resistance Plastic Wheels

Ref 051-004

~~153,52 €~~ **90,31 €**      505 x 330 x 835 mm

**TROLLEY**  
**2 MODULES**



- 1 Tool Box
- Round Organizer
- 1 High Capacity Chest
- Frontal Nylon Bag

Ref 051-005

~~95,64 €~~ **56,26 €**      485 x 310 x 635 mm

**TOOL BOX**  
**1 TRAY + 3 ORGANIZERS**

- Double Metal Safety Lock
- Portable Tray Inside



490 x 262 x 250 mm

Ref 050-010

~~39,85 €~~ **22,27 €**

**PROFESSIONAL**  
**TOOL BOX**



593 x 310 x 282 mm

- 1 Portable Tray Inside
- Front and Side Metal Faces
- Double Metal Safety Lock

Ref 050-005

~~99,38 €~~ **55,54 €**

**ORGANIZER**  
**BOX**



- Top Tray

Ref 052-002

~~46,07 €~~ **27,10 €**

279 x 184 x 254 mm

**SOLID HANDLE**  
**ORGANIZER**



- Removable Organizing Cases

Ref 052-006

~~15,06 €~~ **8,86 €**

210 x 338 x 62 mm



**TOOL BOX  
+50 INDUSTRIAL QUALITY TOOLS**

- Professional Metal Tool Box Ref:026-001
- 5 High Capacity Trays
- Maximum Total Load 30Kg

Ref 026-500

~~624,96 €~~ **360,78 €**

**PROFESSIONAL COMPOSITION**  
Includes Tool Box and 50 Tools



495 x 200 x 230 mm



- |           |           |                |             |               |               |               |            |
|-----------|-----------|----------------|-------------|---------------|---------------|---------------|------------|
| 1 205-180 | 5 296-006 | 9 605-009      | 334-PH1-100 | 11 701-455    | 746-04-10     | 14 776-03     | 18 840-002 |
| 2 212-180 | 6 296-021 | 10 330-055-100 | 334-PH2-125 | 12 783-02-400 | 746-05-10     | 15 789-002    | 19 026-001 |
| 3 271-225 | 7 491-250 | 331-040-125    | 337-PZ1-100 | 13 749-06-12  | 755-12-10-200 | 16 792-02-200 |            |
| 4 268-250 | 8 451-002 | 331-065-150    | 337-PZ2-125 | 746-03-10     | 754-04-16-250 | 17 830-021    |            |

**TOOL BOX  
5 TRAYS**

495 x 200 x 230 mm

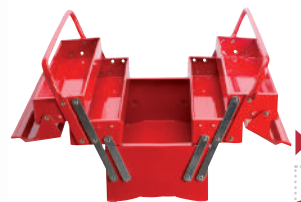

Ref 026-001

~~72,71 €~~ **41,70 €**

**TOOL BOX  
3 TRAYS**

495 x 200 x 180 mm



Ref 026-002

~~57,43 €~~ **32,94 €**

**TOOL BOX  
5 TRAYS LONG SERIES**

550 x 200 x 208 mm



Ref 026-005

~~84,49 €~~ **49,70 €**



**ROLLER  
TOOL BOX**



750 x 650 x 440 mm



- 2 Floors
- Double Metal Safety Lock

▶ Ref 051-007  
~~219,12 €~~ **122,45 €**

**ROLLER  
TOOL BOX**



620 x 370 x 420 mm



- 3 Accessory Organizers

▶ Ref 051-006  
~~125,63 €~~ **70,21 €**

**TOOL BOX  
1 TRAY + 6 DRAWERS**



- Top Tray
- Side Handle
- Safety Lock with Key

668 x 316 x 386 mm

▶ Ref 028-001  
~~404,32 €~~ **225,95 €**

**TOOL BOX  
1 TRAY + 2 DRAWERS**



- Double Metal Safety Lock
- Inner Tray

510 x 218 x 250 mm

- Open top tray to unlock drawers

▶ Ref 026-003  
~~102,33 €~~ **57,18 €**

# GOBOX

by DOGHER TOOLS

## WATERPROOF TROLLEY

- Waterproof and airtight (IP 67)
- Interstackable
- Corrosionproof, sandproof and dustproof
- Shockproof and crushproof
- Temperature rating -33°C/+90°C
- Ergonomic handle, rubber coated grip
- Jam free latches with user-friendly opening mechanism
- Corrosion proof metal hinges with lid stay features
- Automatic pressure release valve
- Sealing O-ring
- External sizes: 568x467x274mm/Internal sizes: 546x392x233mm
- Lid depth: 54 mm / Base depth: 179 mm



Ref 051-010

Ref 051-010

~~484,00 €~~ **284,71 €**

568 x 467 x 274 mm

## TROLLEY INDUSTRIAL TOOLS



**139**  
Pcs



Ref 051-510

~~1.767,05 €~~ **1.013,46€**



## TROLLEY ELECTRICIANS TOOLS

**139**  
Pcs

Ref 051-511

~~1.860,22 €~~ **1.066,89 €**

### PROFESSIONAL RUCKSACK

+ 1 ORGANIZER + 32 TOOLS



Ref 076-500

~~378,07 €~~ 222,40 €

### ELECTRICIANS RUCKSACK

+ 1 ORGANIZER + 29 TOOLS



Ref 076-501

~~353,37 €~~ 207,87 €

### HEAVY DUTY NYLON UNIVERSAL

OPEN TOOL BOX

- High Storage Capacity
- Resistant lining with specific pockets
- Handle and Shoulder Strap for Comfortable carrying
- Fast opening with buckle fastening



515 x 185 x 170 mm



Ref 076-001

~~90,72 €~~ 53,36 €

\* Tools not included

### NYLON UNIVERSAL OPEN

TOOL BOX

- Reinforced handling bar
- High storage capacity
- Water resistant inner lining
- Specific pockets for tools
- Handle and Shoulder Strap for comfortable carrying



410 x 215 x 335 mm



Ref 076-002

~~70,26 €~~ 41,33 €

\* Tools not included

### TOOL BAG GATE

MOUTH 20"

- Rigid opening for an easy use
- High storage capacity
- Water resistant inner lining



520 x 250 x 290 mm

Ref 076-012

~~72,31 €~~ 42,54 €

\* Tools not included

### TOOL WRAP

WITH HANDLE

- Reinforced ergonomic carrying handle
- 18 Versatile compartments
- Adjustable belts



350 x 85 x 195 mm



Ref 076-003

~~45,62 €~~ 26,84 €

\* Tools not included

### UNIVERSAL

TOTE

- High Storage Capacity, indispensable for the professional
- Shoulder Strap for Comfortable carrying
- Specific pockets for tools both inside and outside



290 x 185 x 220 mm



Ref 076-006

~~50,89 €~~ 29,94 €

\* Tools not included

## MULTI CIRCLIPS®

### PLIER



Knot position for internal Seeger circlip handling



Knot position for external Seeger circlip handling



Interchangeable bent tips



Interchangeable straight tips



Storage for spare tips

- Internal / external Straight and Bent Tips
- Includes 3 pairs of spare tips:  
2 pairs of straight tips + 1 pair of Bent Tips

6 IN 1

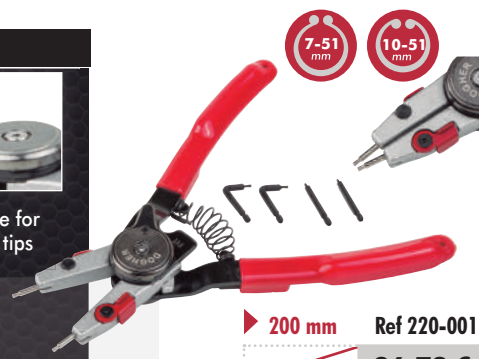

▶ 200 mm Ref 220-001  
~~45,52 €~~ 26,78 €

### STRAIGHT TIPS EXTERNAL

#### CIRCLIP® PLIER PRO



L mm	∅ Min mm.	∅ Max mm.	Ref		
▶ 155	12	25	220-155	<del>18,35 €</del>	8,10 €
180	19	60	220-180	<del>21,03 €</del>	9,28 €
220	40	100	220-220	<del>23,87 €</del>	10,53 €
300	85	165	220-300	<del>37,62 €</del>	16,60 € ▶

### BENT TIPS EXTERNAL

#### CIRCLIP® PLIER PRO



L mm	∅ Min mm.	∅ Max mm.	Ref		
▶ 155	10	25	221-155	<del>18,35 €</del>	8,10 €
180	19	60	221-180	<del>21,03 €</del>	9,28 €
220	40	100	221-220	<del>23,87 €</del>	10,53 €
300	85	165	221-300	<del>37,62 €</del>	16,60 € ▶

### STRAIGHT TIPS INTERNAL

#### CIRCLIP® PLIER PRO



L mm	∅ Min mm.	∅ Max mm.	Ref		
▶ 155	12	25	222-155	<del>18,35 €</del>	8,10 €
180	19	60	222-180	<del>21,03 €</del>	9,28 €
220	40	100	222-220	<del>23,87 €</del>	10,53 €
300	85	165	222-300	<del>37,62 €</del>	16,60 € ▶

### BENT TIPS INTERNAL

#### CIRCLIP® PLIER PRO



L mm	∅ Min mm.	∅ Max mm.	Ref		
▶ 155	12	25	223-155	<del>18,35 €</del>	8,10 €
180	19	60	223-180	<del>21,03 €</del>	9,28 €
220	40	100	223-220	<del>23,87 €</del>	10,53 €
300	85	165	223-300	<del>37,62 €</del>	16,60 € ▶

## SET ZIPPING

### 3 PLIERS

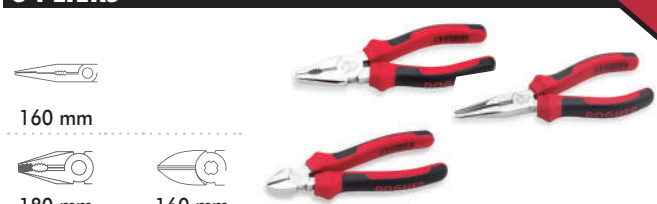

160 mm

180 mm

160 mm

▶ Ref 210-002  
~~59,47 €~~ 34,98 €

NEW



## SCREW LOCKING

### KNIFE CUTTER

- Screw to tighten the blade at the required length.
- Storage for spare blades.

18 mm



▶ 160 mm Ref 789-001  
~~4,70 €~~ 2,70 €

## RETRACTILE

### KNIFE CUTTER

- Includes 4 spare blades
- Quick release



▶ 145 mm Ref 790-030  
~~23,66 €~~ 13,92 €

# CIRCLIP® PLIERS PRO



- Reinforced tips.
- Internal spring.
- Higher resistance and durability
- Anti-slip handle



## STRAIGHT TIPS EXTERNAL CIRCLIP® PLIER PRO



L mm	∅ Min mm.	∅ Max mm.	Ref	<del>Price</del>	Price
▶ 140	3	10	220X-140	<del>22,60 €</del>	13,29 €
140	10	25	220X-155	<del>20,18 €</del>	11,87 €
180	19	60	220X-180	<del>23,57 €</del>	13,86 €
240	40	100	220X-220	<del>27,25 €</del>	16,03 €
330	85	140	220X-300	<del>45,00 €</del>	26,47 € ▶

## BENT TIPS EXTERNAL CIRCLIP® PLIER PRO



L mm	∅ Min mm.	∅ Max mm.	Ref	<del>Price</del>	Price
▶ 130	3	10	221X-140	<del>22,60 €</del>	13,29 €
130	10	25	221X-155	<del>20,57 €</del>	12,10 €
170	19	60	221X-180	<del>23,24 €</del>	13,67 €
220	40	100	221X-220	<del>27,75 €</del>	16,32 €
315	85	140	221X-300	<del>45,00 €</del>	26,47 € ▶

## STRAIGHT TIPS INTERNAL CIRCLIP® PLIER PRO



L mm	∅ Min mm.	∅ Max mm.	Ref	<del>Price</del>	Price
▶ 140	8	13	222X-140	<del>22,60 €</del>	13,29 €
140	12	25	222X-155	<del>20,57 €</del>	12,10 €
180	19	60	222X-180	<del>23,57 €</del>	13,86 €
230	40	100	222X-220	<del>27,25 €</del>	16,03 €
320	85	140	222X-300	<del>45,00 €</del>	26,47 € ▶

## BENT TIPS INTERNAL CIRCLIP® PLIER PRO



L mm	∅ Min mm.	∅ Max mm.	Ref	<del>Price</del>	Price
▶ 125	8	13	223X-140	<del>22,60 €</del>	13,29 €
125	12	25	223X-155	<del>20,57 €</del>	12,10 €
170	19	60	223X-180	<del>23,57 €</del>	13,86 €
220	40	100	223X-220	<del>28,00 €</del>	16,47 €
300	85	140	223X-300	<del>45,00 €</del>	26,47 € ▶

## SET ZIPPING 4 CIRCLIP® PLIERS PRO

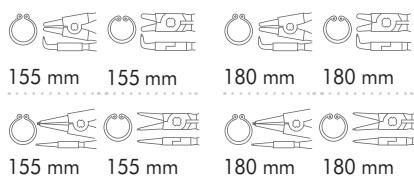

L mm	∅ Min mm.	∅ Max mm.	Ref	<del>Price</del>	Price
▶ 155	12	25	220X-004	<del>90,14 €</del>	53,02 €
180	19	60	220X-002	<del>102,20 €</del>	60,12 € ▶



290 x 215mm

## NYLON POUCH 4 CIRCLIP® PLIERS PRO

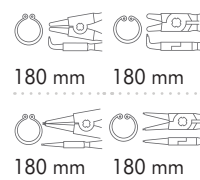

225 x 300

∅ Min.	∅ Max.	Ref	<del>Price</del>	Price
19	60	220X-001	<del>100,20 €</del>	58,94 €

### PROFESSIONAL ALUMINIUM PIPE WRENCH

- 60HRc jaw hardness
- 38% more opening than forged pipe wrench
- Aluminium body, 40% lighter
- Monoblock body, higher strenghtness



CrV



L"	L mm	Ø max.	Ref	<del>Price</del>	Price
▶ 10	250	Ø49	655-250	<del>37,30 €</del>	21,94 €
14	350	Ø60	655-350	<del>52,65 €</del>	30,97 €
18	450	Ø76	655-450	<del>78,61 €</del>	46,24 €
24	600	Ø90	655-600	<del>102,87 €</del>	60,51 €
36	900	Ø140	655-900	<del>205,03 €</del>	120,61 € ▶

### PROFESSIONAL SPANISH TYPE PIPE WRENCH

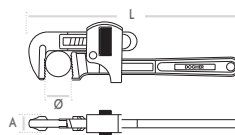

60HRc

CrV



L"	L mm	Ø max.	Ref	<del>Price</del>	Price
▶ 8	200	Ø25	650-200	<del>19,56 €</del>	11,50 €
10	250	Ø35	650-250	<del>27,64 €</del>	16,26 €
12	300	Ø44	650-300	<del>31,80 €</del>	18,71 €
14	350	Ø50	650-350	<del>35,15 €</del>	20,67 €
18	450	Ø60	650-450	<del>47,51 €</del>	27,95 €
24	600	Ø76	650-600	<del>74,86 €</del>	44,03 €
36	900	Ø102	650-900	<del>164,37 €</del>	96,69 € ▶

### PROFESSIONAL S TYPE BENT NOSE PIPE WRENCH

CrV

60HRc

L mm	Ø mm	Ø"	Ref	<del>Price</del>	Price
▶ 425	60	1.1/2	660-425	<del>41,46 €</del>	24,39 € ▶



### PVC PIPE CUTTER AUTOMATIC RETURN

Includes:  
Plastic Accessory for Flat Surfaces Cutting



PVC

Ø mm  
0~45



▶ 0-45 mm	Ref 665-45
<del>63,58 €</del>	37,40 €

### ZIP ACTION TUBE CUTTER

Cu

Al

Inox



Ø mm  
3~32



▶ 3-32 mm	Ref 675-03-32
<del>21,40 €</del>	12,59 €

Includes Deburring Tool

### UNIVERSAL CONTROL CABINET KEY WATER, GAS

- ◻ 6-8 mm
- 9 mm
- ⊕ PH2
- ▲ 9 mm
- Adapt. 1/4"
- ◌ 7 mm



▶	Ref 470-001
<del>20,01 €</del>	11,77 €

### UNIVERSAL SWITCH CABINET KEY HEAT, AC

- ◻ 6-8 mm
- ◄ 10 mm
- ⊕ PH2
- ▲ 9 mm
- Adapt. 1/4"
- ◌ 7 mm



▶	Ref 470-002
<del>20,37 €</del>	11,98 €

### MULTIFUNCTIONAL CABINET KEY

- ◻ 5 / 6-7 / 6-8 / 10-11 mm
- Adapt. 1/4"
- ▲ 7-8 mm
- ▲ 9-10 mm
- ▲ 11-12 mm
- ⊕ PH2
- ◌ 7 mm
- ◻ 6-9 mm
- 3/5 mm
- 6 mm

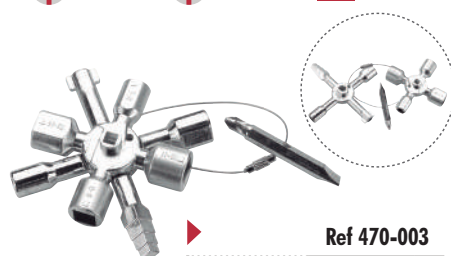

▶	Ref 470-003
<del>28,88 €</del>	16,99 €

**BUTTON FUNCTION  
WATER PUMP PLIER**

- Longest+finest jaws: Better accessibility
- Chrome Vanadium Forged Steel body
- PVC anti-slip handle
- Anti-rust black finished
- Hardened jaws higher resistance and durability
- 4 teeth locking button
- 35% more opening



CrV



L mm	Ø max. mm	Ref		
▶ 180	38	269-180	<del>35,70 €</del>	21,00 €
240	50	269-240	<del>38,09 €</del>	22,41 €
300	70	269-300	<del>47,30 €</del>	27,82 €
400	90	269-400	<del>84,84 €</del>	49,91 € ▶

**STANDARD BUTTON FUNCTION  
WATER PUMP PLIER**



L mm	Ø max. mm	Ref		
▶ 250	50	2690-250	<del>27,67 €</del>	14,65 €
300	70	2690-300	<del>37,84 €</del>	21,14 € ▶

**TWIN SLIP-JOINT  
WATER PUMP PLIER**

CrV



L mm	Ø mm	Ref		
▶ 250	37	268-250	<del>20,57 €</del>	12,10 € ▶

**ANTI-SLIP HANDLE TWIN SLIP-JOINT  
WATER PUMP PLIER**

CrV



L mm	Ø mm	Ref		
▶ 250	48	267-250	<del>27,63 €</del>	16,25 € ▶

**EXPERT RATCHET  
CRIMPING TOOL**



- Insulated terminal crimping range 1.5-2,5-6 mm<sup>2</sup>
- Hardened & tempered steel
- Ratchet mechanism controlled, accurate crimping
- Force amplifying ratchet mechanism
- Handle locking function
- Ergonomic handle

▶ 220 mm	Ref 296-060
<del>28,77 €</del>	16,92 €

## SELF ADJUSTING LOCKING PLIER WITH WIRE CUTTER

10 UNITS



- Pressure adjustment by internal mechanism.
- Non-slip knurled handles.
- AUTOMATIC Patented locking plier.



NEW



CrMo 250 mm 10" Ø mm 38



Ref 275-010J  
~~412,20 €~~ 242,47€

▶ 250 mm Ref 275-010  
~~41,22 €~~ 24,25 €

## CURVED JAWS LOCKING PLIER WITHOUT WIRE CUTTER



100%  
More grip power

L mm	L"	Ref	<del>22,50 €</del>	13,23 €
▶ 175	7	275-175		
250	10	275-250	<del>25,55 €</del>	15,03 €

- Curved Jaws
- Large opening jaws indicated for round shapes.
- Used in workshops, plumbing, heaters...
- A great capacity curved and fine jaws: Firm grip on rounded forms



## HIGH CAPACITY FRENCH TYPE LOCKING PLIERS

### STRAIGHT JAWS LOCKING PLIER



L mm	Ø mm	P mm	Ref	<del>64,18 €</del>	37,58 €
▶ 220	55	45	275F-010		

### CURVED JAWS LOCKING PLIER



L mm	Ø mm	P mm	Ref	<del>63,24 €</del>	37,40 €
▶ 250	85	73	275F-011		

### SWIVEL PADS LOCKING PLIER



L mm	Ø mm	P mm	Ref	<del>73,26 €</del>	43,25 €
▶ 250	80	70	275F-012		

### C CLAMPS LOCKING PLIER



L mm	Ø mm	P mm	Ref	<del>74,78 €</del>	44,24 €
▶ 270	100	90	275F-013		



## CUT-PRO SCISSORS

### Features:

- Anti slip blade with micro-indentation
- Bi material handle
- Wire cutting notch.

Inox



# CUT PRO

## CUT-PRO ELECTRICIAN SCISSORS XXL



Inox

- Max. cutting capacity: 1x50 mm<sup>2</sup>
- Integral steel body
- Crimping terminal of cable & Wire cutting notch: 1,5mm<sup>2</sup> / 2,5mm<sup>2</sup>.

▶ 160 mm Ref 296-009  
~~27,00 €~~ 15,88 €

## CUT-PRO ELECTRICIAN SCISSORS



▶ 150 mm Ref 296-008  
~~17,47 €~~ 10,28 €

## HEAVY DUTY LARGE ELECTRICIAN SCISSORS GRIP XXL

- Serrated Blade
- Bi-material handle
- Maximum cutting capacity 1 x 50 mm<sup>2</sup>



Inox ▶ 150 mm Ref 296-004  
~~21,19 €~~ 12,30 €

## PROFESSIONAL ELECTRICIAN SCISSORS



- Serrated Blade
- Bi-material handle

Inox



▶ Ref Scissor+Holster 296-007  
~~19,89 €~~ 10,82 €

▶ 145 mm Ref 296-006  
~~16,83 €~~ 9,90 €

## CABLE & WIRE STRIPPER



- Ø 4 - 28 mm 5/32" - 1 1/8"
- Ø 0,5 - 6 mm<sup>2</sup> 20 - 10 AWG



▶ Ref 296-132  
~~31,52 €~~ 18,54 €

## SELF-ADJUSTING AUTOMATIC WIRE STRIPPING



- Ø 0,2-6 mm<sup>2</sup> 24-10 AWG



▶ Ref 296-152  
~~39,95 €~~ 23,50 €

## COAXIAL CABLE STRIPPER

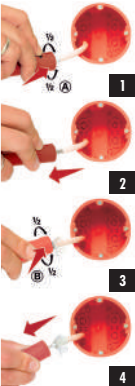

- Ø 4,8-7,5 mm 5/32"-3/16"



▶ Ref 296-170  
~~27,25 €~~ 16,03 €

## SELF-ADJUSTING AUTOMATIC WIRE STRIPPING



- Ø 0,5-16 mm<sup>2</sup> 20-6 AWG



▶ Ref 296-252  
~~83,36 €~~ 49,04 €

## SCREWDRIVERS INSULATED 1000V

Insulated Screwdriver 1000V  
Insulated Round Blade  
VDE Certificate with Guarantee  
56 HRc



### 6 SCREWDRIVERS INSULATED 1000V

- Milled  
3·4·5,5·6,5
- PH1·PH2

Ref 360-005

~~52,58 €~~ 29,38 €

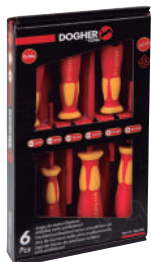

### 7 SCREWDRIVERS INSULATED 1000V

- Milled  
3·4·5,5·6,5
- PH0·PH1·PH2

Ref 360-001

~~64,65 €~~ 34,91 €



### SET ZIPPING WITH 5 TOOLS INSULATED 1000V

Insulated Diagonal Cutting  
Ref. 255-160

- Milled 4 · 5,5
- PH1 · PH2

Ref 360-008

~~65,87 €~~ 33,55 €

Insulated Diagonal Cutting  
Ref. 255-160

- Milled 4 · 5,5
- PZ1 · PZ2

Ref 360-009

~~66,37 €~~ 33,81 €



## SCREWDRIVER & PLIERS SETS

### INTERCHANGEABLE PROFESSIONAL SCREWDRIVER SET 14 PIECES



1 Handle  
1 Cup  
1 Tester  
11 Interchangeable Blades:



- 2,5 · 3,5 · 4,0 · 5,5 · 6,5
- PH0 · PH1 · PH2
- T10 · T15 · T20



Ref 360-012

~~68,00 €~~ 40,00 €

### INTERCHANGEABLE PROFESSIONAL SCREWDRIVER SET 13 PIECES



1 Handle  
1 Tester  
11 Interchangeable Blades:



- 2,5 · 3,0 · 3,5 · 4,0 · 5,5 · 6,0
- PH0 · PH1 · PH2
- PZ/FL1 · PZ/FL2



Ref 360-013

~~89,00 €~~ 52,35 €

### SET ZIPPING 3 INSULATED PLIERS



160 mm



180 mm



160 mm

NEW

Ref 250-002

~~94,53 €~~ 48,16 €





**INSULATED SOCKET SET**  
20 PIECES



80 mm  
320 mm  
415 mm



10 · 11 · 12 · 13 · 14 · 16 · 17 · 18 · 19 · 21 · 22 · 24 · 27

Sockets Bits

4 · 5 · 6 · 8 · L 120 mm

Ratchet Handle L 250 mm



Extension 250 mm



Sliding "T" L 200 mm



Ref 5331-001

~~455,36 €~~ **267,86 €**

**VDE CASE**  
19 PIECES



390 mm  
675 mm  
705 mm



Insulated long nose plier with cut

251-200



Insulated wire stripping plier

257-160



4 Precision Screwdrivers + cups



Tester

396-001

2 insulating tape roll



Insulated Milled Screwdriver

360-025-075  
360-040-100  
360-055-125  
360-065-150  
360-080-175



Insulated Phillips Screwdriver

361-PH0-060  
361-PH1-080  
361-PH2-100

Insulated Heavy duty diagonal plier



255-160

Insulated combination plier



250-180

Ref 080-001

~~221,74 €~~ **130,43 €**

## INDUSTRIAL PLUS SERIES

### SCREWDRIVER

- Anti-slip polyurethane
- High resistance polyamid
- Double reinforcement
- Hex blade & hex bolster
- 58 HRc hardness

S2



HIGHER STEADINESS

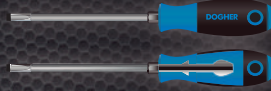

## 6 SCREWDRIVERS

### INDUSTRIAL PLUS SERIES

Milled 3 · 4 · 5 · 6

PH1 · PH2

Ref 300-001

~~51,81 €~~ 27,43 €



## INDUSTRIAL SERIES

### SCREWDRIVERS

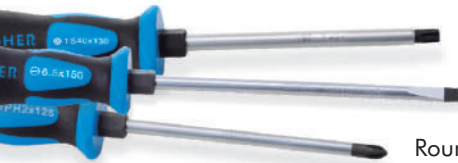

Round Blade  
Hex-Bolster  
56 HRc

## 5 SCREWDRIVERS

### INDUSTRIAL SERIES

CrMo



Milled 5,5 · 6,5

PH1 · PH2 · PH3

Ref 315-001

~~43,08 €~~ 23,76 €

## SCREWDRIVERS

### PROFESSIONAL SERIES

Round Blade Bi-material handle 56 HRc

CrMo



## 5 SCREWDRIVERS

### PROFESSIONAL SERIES



Stamped 5,5 · 6,5

PH1 · PH2 · PH3

Ref 330-001

~~37,14 €~~ 21,30 €

## 7 SCREWDRIVERS

### PROFESSIONAL SERIES



Stamped 3-4-5,5-6,5

PH0 · PH1 · PH2

Ref 330-003

~~41,99 €~~ 24,08 €

## 7 SCREWDRIVERS

### PROFESSIONAL SERIES



Stamped 3-4-5,5-6,5

PZ0 · PZ1 · PZ2

Ref 330-004

~~43,27 €~~ 24,82 €

## PRECISION SCREWDRIVERS

Round Blade  
Bi-Material Handle  
56 HRc

CrMo



1,5-2-2,5-3

PH00 · PH0 · PH1

Ref 380-002

~~32,39 €~~ 19,05 €



## OFFSET BIT HOLDER FOR 1/4" BITS

- Suitable for screwdriver bits and hex shank drill bits
- Designed for a comfortable work in limited spaces
- To be used exclusively in cordless drivers

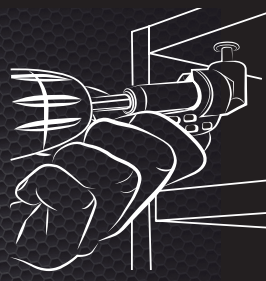

Ref 443-001

~~28,35 €~~ 16,68 €

## FLEXIBLE RATCHETING SCREWDRIVER

- Reversible
- Ergonomic bi-material handle
- Safety fixing Ball
- Unlocking button

1/4" CrV

0° - 45° - 90° POSITIONS



▶ 180mm Ref 343-007  
~~17,06 €~~ 10,04 €

## 58 PIECES RATCHETING SCREWDRIVER BIT SET

- 3 · 4 · 4,5 · 5 · 6 · 7 · 8
  - PH0 · PH1 · PH2 · PH3
  - PZ0 · PZ1 · PZ2 · PZ3
  - T5 · T6
  - TS7 · TS8 · TS9 · TS10 · TS15  
TS20 · TS25 · TS30 · TS40
  - HX1,5
  - HXS2,0 · HXS2,5 · HXS3,0  
HXS4,0 · HXS5,0 · HXS6,0
  - 1 · 2 · 3
  - XZN4 · XZN5 · XZN6 · XZN8
  - R0 · R1 · R2 · R3
  - TW1 · TW2 · TW3 · TW4
  - TQ06 · TQ08 · TQ10
  - 4 · 6 · 8 · 10
- S2



Adapter  
 1/4" ◀ ▶ 1/4" (509-030)  
 Magnetic Bit Holder  
 with Ring · 60 mm  
 Screwdriver Ref. 343-007

▶ Ref 438-008  
~~61,60 €~~ 36,24 €

## 32 PIECES SCREWDRIVER BIT SET & BIT HOLDER

- T06 · T07 · T08 · T09 · T10 · T15  
T20 · T25 · T27 · T30 · T40
- HX3 · HX4 · HX5 · HX6
- 3 · 4 · 5 · 6 · 7
- PH0 · PH1 · PH2 (x3) · PH3
- PZ0 · PZ1 · PZ2 · PZ3

Adapter 1/4" ◀ ▶ 1/4" (509-030)  
 Magnetic Bit Holder with Ring · 60 mm



▶ Ref 438-001  
~~36,81 €~~ 21,11 €

## INTERCHANGEABLE PROFESSIONAL SCREWDRIVER SET

1 Blade holder handle  
 10 Interchangeables blades with 2 different bits each

**20 screwdrivers in 1** Double bit blades  
 The screwdriving solution in your pocket !!!



- 3 · 4
- PH0 · PH1
- PZ0 · PZ1
- T10 · T15
- HX2 · HX3
- 5,5 · 6,35
- PH2 · PZ2
- PZ/FL1 · PZ/FL2
- T20 · T25
- HX4 · HX5



▶ Ref 330-050  
~~60,91 €~~ 35,83 €

## 51 PIECES PRECISION SCREWDRIVER BIT SET

- 1 · 1,5 · 2 · 2,5 · 3 · 3,5 · 4
- PH000 · PH00 · PH0 · PH1
- PZ000 · PZ00  
PZ0 · PZ1 · PZ2
- T3 · T4 · T5 · T6 · T7  
T8 · T9 · T10 · T15 · T20
- TS7 · TS8 · TS9 · TS10  
TS15 · TS20
- HX0,7 · HX0,9 · HX1,3  
HX1,5 · HX2,0 · HX2,5  
HX3,0 · HX3,5 · HX4,0
- HS2,0 · HS2,5  
HS3,0 · HS4,0
- HR1,5 · HR2,0 · HR2,5  
HR3,0 · HR4,0

5/32" 28 mm

▶ Ref 380-005  
~~67,36 €~~ 39,62 €



## ADJUSTABLE WRENCHES

CrV

Maximum precision adjustment of the jaws  
Higher rigidity when tightening  
Accurate screw drive, no looseness  
15° angle, increases torque with less effort

15°



### SPANISH ADJUSTABLE WRENCH



L mm	L"	mm	Ref		
▶ 150	6	24	491-150	<del>28,49 €</del>	<b>16,76 €</b>
200	8	29	491-200	<del>31,64 €</del>	<b>18,61 €</b>
250	10	33	491-250	<del>39,25 €</del>	<b>23,09 €</b>
300	12	38	491-300	<del>50,66 €</del>	<b>29,80 €</b>
400	16	50	491-400	<del>84,66 €</del>	<b>49,80 €</b>
500	20	62	491-500	<del>149,33 €</del>	<b>87,84 €</b> ▶

### PROFESSIONAL ADJUSTABLE PRO WRENCH



L mm	L"	mm	Ref		
▶ 100	4	17	493-100	<del>18,55 €</del>	<b>10,91 €</b>
150	6	24	493-150	<del>19,27 €</del>	<b>11,34 €</b>
200	8	29	493-200	<del>22,13 €</del>	<b>13,02 €</b>
250	10	33	493-250	<del>27,28 €</del>	<b>16,05 €</b>
300	12	38	493-300	<del>36,77 €</del>	<b>21,63 €</b>
380	15	50	493-380	<del>62,54 €</del>	<b>36,79 €</b>
450	18	60	493-450	<del>97,32 €</del>	<b>57,24 €</b>
600	24	70	493-600	<del>239,56 €</del>	<b>140,92 €</b> ▶

### RATCHETING ADJUSTABLE WRENCH



15°

CrV

"TIGHTEN WITHOUT LIFTING THE TOOL"

Put the wrench like in picture

- Special for use in difficult access places.

### ADJUSTABLE STD WRENCH



L mm	L"	mm	Ref		
▶ 100	4	13	4930-100	<del>16,70 €</del>	<b>9,82 €</b>
150	6	19	4930-150	<del>17,34 €</del>	<b>10,20 €</b>
200	8	24	4930-200	<del>19,91 €</del>	<b>11,71 €</b>
250	10	28	4930-250	<del>24,55 €</del>	<b>14,44 €</b>
300	12	34	4930-300	<del>32,10 €</del>	<b>18,88 €</b>
380	15	43	4930-380	<del>56,29 €</del>	<b>33,11 €</b>
450	18	52	4930-450	<del>87,58 €</del>	<b>51,52 €</b>
600	24	62	4930-600	<del>170,88 €</del>	<b>100,52 €</b> ▶

### EXTRA WIDE ADJUSTABLE WRENCH



L mm	L"	mm	Ref		
▶ 150	6	6~20	496-150	<del>27,85 €</del>	<b>16,38 €</b>
200	8	6~24	496-200	<del>31,97 €</del>	<b>18,81 €</b>
250	10	6~30	496-250	<del>47,48 €</del>	<b>27,93 €</b> ▶

L mm	L"	mm	Ref		
▶ 150	6	34	492-150	<del>27,67 €</del>	<b>16,28 €</b>
200	8	38	492-200	<del>30,01 €</del>	<b>17,65 €</b>
250	10	50	492-250	<del>36,78 €</del>	<b>21,64 €</b> ▶

# 10 ADJUSTABLE WRENCHES



**Alligator**

CrV 200 mm · 8" Alligator  
32 mm M3-M10 CrV

**NEW**



Ref 4931-200  
~~344,50 €~~ 202,65 €

Ref 4931-200  
~~33,10 €~~ 20,26 €

# DOUBLE OPEN END WRENCH



# 6 DOUBLE OPEN END WRENCHES

6x7 · 8x9 · 10x11 · 12x13 · 14x15 · 16x17



Ref 450-016  
~~37,83 €~~ 22,25 €

# 8 DOUBLE OPEN END WRENCHES

6x7 · 8x9 · 10x11 · 12x13 · 14x15 · 16x17 · 18x19 · 20x22



Ref 450-038  
~~58,57 €~~ 34,45 €



390 x 300 mm

Ref 450-001  
~~61,82 €~~ 36,36 €



Ref 450-018  
~~58,57 €~~ 34,45 €

# 10 DOUBLE OPEN END WRENCHES

6x7 · 8x9 · 10x11 · 12x13 · 14x15 · 16x17 · 18x19 · 20x22 · 21x23 · 24x27



Ref 450-020  
~~85,72 €~~ 50,42 €

# 12 DOUBLE OPEN END WRENCHES

6x7 · 8x9 · 10x11 · 12x13 · 14x15 · 16x17 · 18x19 · 20x22 · 21x23 · 24x27 · 25x28 · 30x32



Ref 450-002 620 x 350 mm  
~~126,27 €~~ 74,27 €

## COMBINATION WRENCHES

- Maximum load distribution
- Quick tightening
- Maximum performance without wear
- Decreases damage to nuts and bolts

- Longer lifetime of the wrench
- Maximum contact surface
- Homogeneous stress distribution

CrV

Effect of stress:

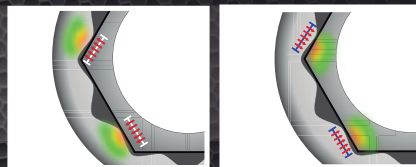

- On the wrench
- On the nut



### 8 COMBINATION WRENCHES

8 · 10 · 11 · 12 · 13 · 14 · 17 · 19



Ref 451-018

~~79,33 €~~ 46,66 €

### 12 COMBINATION WRENCHES

8 · 9 · 10 · 11 · 12 · 13 · 14 · 15 · 16 · 17 · 18 · 19



Ref 451-022

~~119,54 €~~ 70,32 €

### 14 COMBINATION WRENCHES

9 · 10 · 11 · 12 · 13 · 14 · 15  
16 · 17 · 18 · 19 · 20 · 21 · 22



470 x 390 mm

Ref 451-001

~~162,23 €~~ 95,43 €

8 · 9 · 10 · 11 · 12 · 13 · 14  
17 · 19 · 22 · 24 · 27 · 30 · 32



650 x 440 mm

Ref 451-002

~~209,07 €~~ 122,98 €

### 17 COMBINATION WRENCHES

6 · 7 · 8 · 9 · 10 · 11 · 12 · 13 · 14 · 15  
16 · 17 · 18 · 19 · 20 · 21 · 22



470 x 450 mm

Ref 451-003

~~180,95 €~~ 97,13 €

### 18 COMBINATION WRENCHES

8 · 9 · 10 · 11 · 12 · 13 · 14 · 15 · 16  
18 · 19 · 22 · 23 · 24 · 26 · 27 · 30 · 32



650 x 480 mm

Ref 451-004

~~271,62 €~~ 159,77 €

### 24 COMBINATION WRENCHES

6 · 7 · 8 · 9 · 10 · 11 · 12 · 13 · 14 · 15 · 16 · 17  
18 · 19 · 20 · 21 · 22 · 24 · 26 · 27 · 28 · 30 · 32 · 36

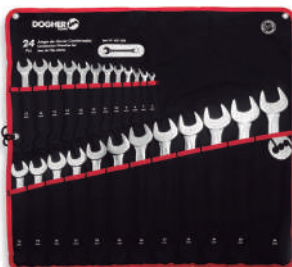

650 x 580 mm

Ref 451-005

~~391,54 €~~ 230,32 €

### 26 COMBINATION WRENCHES

6 · 7 · 8 · 9 · 10 · 11 · 12 · 13 · 14 · 15 · 16 · 17 · 18 · 19  
20 · 21 · 22 · 23 · 24 · 25 · 26 · 27 · 28 · 29 · 30 · 32



650 x 500 mm

Ref 451-006

~~401,07 €~~ 235,92 €



**OFFSET  
COMBINATION WRENCHES**



L mm	mm	Ref	<del>Price</del>	Price
▶ 95	6	4510-06	<del>7,95 €</del>	4,68 €
105	7	4510-07	<del>8,02 €</del>	4,72 €
115	8	4510-08	<del>8,15 €</del>	4,79 €
125	9	4510-09	<del>8,52 €</del>	5,01 €
135	10	4510-10	<del>8,56 €</del>	5,04 €
145	11	4510-11	<del>9,18 €</del>	5,40 €
155	12	4510-12	<del>9,71 €</del>	5,71 €
170	13	4510-13	<del>10,53 €</del>	6,19 €
185	14	4510-14	<del>10,61 €</del>	6,24 €
185	15	4510-15	<del>12,57 €</del>	7,40 €
205	16	4510-16	<del>13,59 €</del>	7,99 €
220	17	4510-17	<del>14,04 €</del>	8,26 €
230	18	4510-18	<del>15,71 €</del>	9,24 €

L mm	mm	Ref	<del>Price</del>	Price
▶ 245	19	4510-19	<del>16,47 €</del>	9,69 €
265	20	4510-20	<del>17,44 €</del>	10,26 €
265	21	4510-21	<del>18,13 €</del>	10,66 €
265	22	4510-22	<del>20,32 €</del>	11,96 €
300	23	4510-23	<del>21,95 €</del>	12,91 €
300	24	4510-24	<del>22,94 €</del>	13,49 €
330	25	4510-25	<del>24,49 €</del>	14,41 €
330	26	4510-26	<del>24,72 €</del>	14,54 €
330	27	4510-27	<del>26,36 €</del>	15,50 €
370	28	4510-28	<del>30,06 €</del>	17,68 €
370	29	4510-29	<del>32,08 €</del>	18,87 €
370	30	4510-30	<del>33,68 €</del>	19,81 €
▶ 390	32	4510-32	<del>35,22 €</del>	20,72 €

**DOUBLE ENDED HEX SOCKET  
WRENCH SETS**



**8 DOUBLE ENDED HEX  
SOCKET WRENCHES**

6x7 · 8x9 · 10x11 · 12x13  
14x15 · 16x17 · 18x19 · 20x22



▶ Ref 460-002  
~~147,18 €~~ **82,68 €**

430 x 380 mm

**12 DOUBLE ENDED HEX  
SOCKET WRENCHES**

6x7 · 8x9 · 10x11 · 12x13 · 14x15 · 16x17  
18x19 · 20x22 · 21x23 · 24x26 · 25x28 · 30x32



▶ Ref 460-004  
~~301,72 €~~ **173,05 €**

520 x 390 mm

**DOUBLE RING OFFSET  
WRENCHES**

**8 DOUBLE RING OFFSET  
WRENCHES**

6x7 · 8x9 · 10x11 · 12x13 · 14x15 · 16x17 · 18x19 · 20x22



▶ Ref 453-002  
~~111,68 €~~ **65,69 €**

390 x 380 mm

**12 DOUBLE RING OFFSET  
WRENCHES**

6x7 · 8x9 · 10x11 · 12x13 · 14x15 · 16x17  
18x19 · 20x22 · 21x23 · 24x27 · 25x28 · 30x32



▶ Ref 453-003  
~~233,05 €~~ **137,09 €**



620 x 480 mm

### 3 4 IN 1

#### GEAR WRENCHES

- 8x13: ○ 8x10 ○ 12x13
- 9x15: ○ 9x11 ○ 14x15
- 16x19: ○ 16x17 ○ 18x19



Ref 475-001  
~~98,50 €~~ 55,04 €

#### COMBINATION REVERSIBLE GEAR WRENCHES



#### 7 COMBINATION REVERSIBLE GEAR WRENCHES

10 · 12 · 13 · 14 · 15 · 17 · 19



Ref 457-017  
~~203,48 €~~ 116,70 €

Ref 457-001 330 x 390 mm  
~~205,98 €~~ 118,13 €

#### 8 COMBINATION REVERSIBLE GEAR WRENCHES

8 · 10 · 12 · 13 · 14 · 15 · 17 · 19



Ref 457-038  
~~224,77 €~~ 128,91 €



#### NON REVERSIBLE COMBINATION GEAR WRENCH



#### 12 COMBINATION GEAR WRENCHES

8 · 9 · 10 · 11 · 12 · 13 · 14 · 15 · 16 · 17 · 18 · 19



Ref 4557-022  
~~225,01 €~~ 132,36 €

#### FLEXIBLE GEAR WRENCHES



#### 5 FLEXIBLE GEAR WRENCHES

8 · 10 · 13 · 17 · 19



Ref 458-015  
~~138,34 €~~ 79,34 €

#### 8 FLEXIBLE GEAR WRENCHES

8 · 10 · 12 · 13 · 14 · 15 · 17 · 19



Ref 458-038  
~~220,02 €~~ 119,07 €

#### 6X6 ANGLED OPEN SOCKET WRENCH



#### 10 6X6 ANGLED OPEN SOCKET WRENCH

6 · 7 · 8 · 10 · 11 · 12 · 13 · 14 · 17 · 19



Ref 462-011  
~~149,33 €~~ 85,65 €

# TORQUE WRENCHES

## PROFESSIONAL TORQUE WRENCH



N*m		L mm		Accur.	Ref	<del>Price</del>	Price
▶ 2-10	0,1	280	1/4"	±3%	625-02-10	<del>202,31 €</del>	119,01 €
10-50	0,25	330	1/4"	±3%	625-10-50	<del>217,57 €</del>	127,98 €
10-60	0,5	340	3/8"	±3%	626-10-60	<del>216,73 €</del>	127,49 €
20-100	0,5	435	3/8"	±3%	627-20-100	<del>225,34 €</del>	132,55 €
40-200	0,5	515	1/2"	±3%	627-40-210	<del>239,80 €</del>	141,06 €
80-400	2	615	1/2"	±3%	627-70-350	<del>295,97 €</del>	174,10 €
100-600	2,5	1050	3/4"	±3%	628-100-500	<del>696,42 €</del>	409,66 €
200-1000	5	1250	3/4"	±3%	628-200-1000	<del>1.169,86 €</del>	688,15 €
300-1.500	10	1850	1"	±3%	629-300-1500	<del>2.077,02 €</del>	1.221,78 €



Instruction Manual & Certificate Included

## STANDARD TORQUE WRENCH



N*m		L mm		Accur.	Ref	<del>Price</del>	Price
▶ 5-25	0,1	280	1/4"	±4%	630-05-25	<del>142,46 €</del>	83,80 €
14-203	0,5	450	1/2"	±4%	632-14-203	<del>201,21 €</del>	118,36 €
50-350	3	570	1/2"	±4%	632-70-350	<del>270,91 €</del>	159,36 €
65-450	1	850	3/4"	±4%	633-65-450	<del>446,17 €</del>	262,45 €



### SUGGESTIONS

Never use a torque wrench to loose bolts or nuts · Stop tightening once you reach the "Click"



Instruction Manual & Certificate Included



The wrench can be used CW direction only.



The wrench can be used CW/CCW direction.

## TORQUE SCREWDRIVER BIT HOLDER

1/4"  
±6%



N*m	L mm	Ø	Accur.	Ref	
▶ 0,1~1,2	180	1/4"	±6%	643-0,1-1,2	<del>213,11 €</del> 125,36 €
▶ 0,4~2	135	1/4"	±6%	643-0,4-2	<del>213,11 €</del> 125,36 €
▶ 1~3,5	195	1/4"	±6%	643-1-3,5	<del>213,11 €</del> 125,36 €

## TORQUE SCREWDRIVER SQUARE DRIVE

1/4"  
±6%



N*m	L mm	Ø	Accur.	Ref	
▶ 0,4~2	135	1/4"	±6%	642-0,4-2	<del>213,11 €</del> 125,36 €

## RATCHET HANDLES

CrV 72<sup>+</sup> Precision  
72Th ratchet



Short Series Available  
Special for difficult access

1/4"	L mm	Ref	
▶	108	510-002	<del>19,62 €</del> 11,26 €
	145	510-001	<del>23,90 €</del> 14,06 € ▶
1/2"	L mm	Ref	
▶	170	544-002	<del>27,61 €</del> 15,43 €
	250	544-001	<del>41,45 €</del> 23,17 € ▶

## SOCKETS SOCKET & RATCHET HANDLE SETS

### IMPACT SOCKETS 1/2" SPECIAL FOR CAR RIMS



1/2"  
17 · 19 · 21



Ref	
▶ 575-001	<del>32,23 €</del> 18,96 €

SOCKETS

SOCKET & RATCHET HANDLE SETS

11 PIECES

1/4" HEX. OR BIHEX. SOCKETS

5 · 6 · 7 · 8 · 9 · 10 · 11 · 12 · 13 · 14



72 Teeth Ratchet Handle

Ref

▶ ○	500-061	<del>63,13 €</del>	<b>36,21 €</b>
▶ ○	501-061	<del>63,13 €</del>	<b>36,21 €</b>



11 PIECES

1/2" BIHEXAGONAL SOCKETS

9 · 10 · 11 · 12 · 13 · 14 · 15 · 17 · 18 · 19



72 Teeth Ratchet Handle

Ref

▶ ○	530-062	<del>102,49 €</del>	<b>49,74 €</b>
-----	---------	---------------------	----------------



13 PIECES

1/2" IMPACT HEXAGONAL SOCKETS

10 · 11 · 12 · 13 · 14 · 17  
19 · 22 · 24 · 27 · 30 · 32



125 mm  
Extension

Ref

▶ ○	570-071	<del>156,37 €</del>	<b>91,98 €</b>
-----	---------	---------------------	----------------

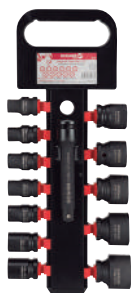

17 PIECES

1/2" HEX. OR BIHEX. SOCKETS

8 · 10 · 11 · 12 · 13 · 14 · 15 · 17 · 19 · 20  
22 · 24 · 27 · 30 · 32



72 Teeth Ratchet Handle   
250 mm Extension

Ref

▶ ○	531-071	<del>165,61 €</del>	<b>80,37 €</b>
▶ ○	530-071	<del>165,61 €</del>	<b>80,37 €</b>



SOCKETS

SOCKET & RATCHET HANDLE SETS

17 PIECES

1/4" HEXAGONAL OR BIHEXAGONAL SOCKETS

4 · 4,5 · 5 · 5,5 · 6 · 7 · 8 · 9  
10 · 11 · 12 · 13 · 14



72 Teeth Ratchet Handle  
Universal Joint  
Extension: 50mm  
3-Way Spinner Handle



Ref

▶ ○	500-001	<del>76,94 €</del>	<b>43,00 €</b>
▶ ○	501-001	<del>76,94 €</del>	<b>43,00 €</b>

260 x 167 x 62 mm

34 PIECES

1/4" HEXAGONAL OR BIHEXAGONAL SOCKETS

4 · 4,5 · 5 · 5,5 · 6 · 7 · 8 · 9 · 10 · 11 · 12 · 13 · 14



1/4" · Screwdriver Bits  
4 · 5,5 · 6,5  
PH1 · PH2 · PH3  
72 Teeth Ratchet Handle  
Universal Joint  
Extension: 50 mm  
Flexible Extension: 145 mm  
3-Way Spinner Handle  
Square Drive Bit Holder 1/4"  
Palm Driver



Ref

▶ ○	500-002	<del>110,10 €</del>	<b>61,53 €</b>
▶ ○	501-002	<del>110,10 €</del>	<b>61,53 €</b>

260 x 167 x 62 mm

47 PIECES

1/4" HEXAGONAL SOCKETS

4 · 4,5 · 5 · 5,5 · 6 · 7 · 8 · 9 · 10 · 11 · 12 · 13 · 14  
Long Serie: 8 · 10 · 11 · 13

Socket Bits  
4 · 5,5 · 6,5  
PH1 · PH2 · PH3

T10 · T15 · T20 · T25 · T30 · T40  
HX3 · HX4 · HX5 · HX6 · HX7 · HX8  
PZ1 · PZ2 · PZ3

Ref

▶ ○	500-003	<del>190,88 €</del>	<b>101,05 €</b>
-----	---------	---------------------	-----------------

72 Teeth Ratchet Handle  
Universal Joint  
Extensions: 50 & 100mm  
Spinner Handle  
Sliding "T" Handle  
Hex Key Wrenches 1,5 · 2 · 2,5



260 x 167 x 62 mm

## SOCKETS

### SOCKET & RATCHET HANDLE SETS

#### 16 PIECES

##### 3/8" HEXAGONAL SOCKETS

8 · 9 · 10 · 11 · 12 · 13  
14 · 15 · 16 · 17 · 18 · 19

72 Teeth Ratchet Handle  
Universal Joint  
Extension: 75 mm  
Palm Driver



CrV 3/8"

Ref  
▶ 516-001 ~~98,50 €~~ **52,15 €** ▶ 260 x 167 x 62 mm

#### 34 PIECES

##### 3/8" HEXAGONAL SOCKETS

6 · 8 · 10 · 11 · 12 · 13 · 14 · 15 · 16 · 17 · 18 · 19

1/4" · Socket Bits T10 · T15 · T20 · T25 · T27 · T30 · T40  
 PH0 · PH1 · PH2 · PH3 HX3 · HX4 · HX5 · HX6

72 Teeth Ratchet Handle  
Universal Joint  
Extensions: 75 & 150 mm  
Spinner Handle  
Sliding "T" Handle  
Adapter 1/4" - 3/8"



Ref  
▶ 516-003 ~~183,13€~~ **96,95 €** ▶ 260 x 167 x 62 mm

#### 14 PIECES

##### 1/2" HEXAGONAL OR BIHEXAGONAL SOCKETS

10 · 11 · 12 · 13 · 14 · 15  
16 · 17 · 18 · 19 · 21 · 22

72 Teeth Ratchet Handle  
Universal Joint

Ref  
▶ 531-001 ~~98,33 €~~ **54,95 €**  
▶ 530-001 ~~98,33 €~~ **54,95 €** ▶  
260 x 167 x 62 mm

CrV 1/2"



#### 19 PIECES

##### 1/2" HEXAGONAL SOCKETS

10 · 11 · 12 · 13 · 14 · 15  
16 · 17 · 18 · 19 · 20 · 21 · 22

72 Teeth Ratchet Handle  
Universal Joint  
Extensions: 125 & 250 mm  
3-Way Adapter 3/8" - 1/2"  
Palm Driver



CrV 1/2"

385 x 280 x 87 mm

Ref  
▶ 531-002 ~~137,62 €~~ **76,91 €** ▶

#### 41 PIECES

##### 1/2" HEXAGONAL OR BIHEXAGONAL SOCKETS

8 · 9 · 10 · 11 · 12 · 13 · 14 · 15 · 16 · 17 · 18 · 19 · 21 · 22 · 24 · 27 · 30 · 32

5/16" · Screwdriver Bits T40 · T45 · T50 · T55 · T60 72 Teeth Ratchet Handle  
 PH3 · PH4 HX7 · HX8 · HX10 · HX12 Universal Joint  
 PZ3 · PZ4 8 · 10 · 12 Extensions: 125 & 250 mm  
Square Drive Bit Holder 5/16" - 1/2"  
3-Way Adapter 3/8" - 1/2"  
Palm Driver

Ref  
▶ 531-003 ~~204,23 €~~ **114,13 €**  
▶ 530-003 ~~204,23 €~~ **114,13 €** ▶ 385 x 280 x 87 mm

CrV 1/2"



#### 16 PIECES

##### 3/4" HEXAGONAL SOCKETS

19 · 22 · 23 · 24 · 27 · 30 · 32 · 36 · 38 · 41 · 46 · 50

24 Teeth Ratchet Handle -500 mm  
Extensions: 100 & 200 mm  
Sliding "T" Handle

Ref  
▶ 549-001 ~~521,99 €~~ **276,35 €** ▶

CrV 3/4"



# SOCKETS

## SOCKET & RATCHET HANDLE SETS

### 76 PIECES

#### 1/4" & 1/2" HEXAGONAL SOCKETS



▶ **1/4"** Socket Bits 4 · 4,5 · 5 · 5,5 · 6 · 7 · 8 · 9 · 10 · 11 · 13

- |                         |                                   |
|-------------------------|-----------------------------------|
| 1/4" · Screwdriver Bits | T10 · T15 · T20 · T25 · T27 · T30 |
| PH0 · PH1 · PH2 · PH3   | HX2 · HX3 · HX4 · HX5 · HX6 · HX7 |
| PZ2 · PZ3               | 3 · 4,5 · 5,5 · 6,5               |

▶ **1/2"** Socket Bits 10 · 11 · 12 · 13 · 14 · 15 · 16 · 17 · 19 · 21 · 24 · 27 · 30 · 32

- |                          |                             |
|--------------------------|-----------------------------|
| 5/16" · Screwdriver Bits | T40 · T45 · T50 · T55 · T60 |
| PH3 · PH4                | HX8 · HX10 · HX12           |
| PZ3 · PZ4                | 8 · 10 · 12                 |

72 Teeth Ratchet Handle 1/4" & 1/2"

Universal Joint 1/4" & 1/2"

Extensions: 1/4" & 1/2": 50&100 - 125&250 mm

3-Way Spinner Handle 1/4"

Square Drive Bit Holder 1/4" & 1/2"

1/4" 5/16" 1/2"

Palm Driver 1/4" & 1/2"

3-Way Spinner Handle 1/2"

3/8" 1/2"



440 x 305 x 92 mm

Ref

▶ **500-025** ~~290,40 €~~ **153,74 €** ▶

### 94 PIECES

#### 1/4" & 1/2" HEXAGONAL SOCKETS



▶ **1/2"** 10 · 11 · 12 · 13 · 14 · 15 · 16 · 17 · 18 · 19 · 20 · 21 · 22 · 24 · 27 · 30 · 32  
Long Series: 14 · 15 · 17 · 19 Spark Plug: 16 · 21

- |                        |                          |
|------------------------|--------------------------|
| 5/16" Screwdriver Bits | T40 · T45 · T50 · T55    |
| PH3 · PH4              | HX8 · HX10 · HX12 · HX14 |
| PZ3 · PZ4              | 8 · 10 · 12              |

▶ **1/4"** Socket 4 · 4,5 · 5 · 5,5 · 6 · 7 · 8 · 9 · 10 · 11 · 12 · 13 · 14  
Long Series: 6 · 7 · 8 · 9 · 10 · 11 · 12 · 13

- |             |                                  |
|-------------|----------------------------------|
| Socket Bits | T8 · T10 · T15 · T20 · T25 · T30 |
| PH1 · PH2   | HX3 · HX4 · HX5 · HX6            |
| PZ1 · PZ2   | 4 · 5,5 · 7                      |

72 Teeth Ratchet Handle 1/4" & 1/2"

Universal Joint 1/4" & 1/2"

Extensions: 50 & 100 - 125 & 200 mm 1/4" & 1/2"

Spinner Handle 1/4"

Flexible Extension 1/4"

Sliding "T" Handle 1/4"

Bit-Holder 5/16" 1/2"

Adapter 3/8" 1/2"

Hex Key Wrenches 1,5 · 2 · 2,5



380 x 300 x 84 mm

Ref

▶ **500-030** ~~176,77 €~~ **66,18 €** ▶

### 108 PIECES

#### 1/4" & 1/2" HEXAGONAL SOCKETS



▶ **1/4"** 4 · 4,5 · 5 · 5,5 · 6 · 7 · 8 · 9 · 10 · 11 · 12 · 13 · 14  
Long Series: 6 · 7 · 8 · 9 · 10 · 11 · 12 · 13

E4 · E5 · E6 · E7 · E8

- |                         |  |
|-------------------------|--|
| 1/4" · Screwdriver Bits | T8 · T10 · T15 · T20 · T25 · T27 · T30 |
| PH1 · PH2               | HX3 · HX4 · HX5 · HX6                  |
| PZ1 · PZ2               | 4 · 5,5 · 6,5                          |

▶ **1/2"** 10 · 11 · 12 · 13 · 14 · 15 · 16 · 17 · 18 · 19 · 20 · 21 · 22 · 24 · 27 · 30 · 32  
Long Series: 14 · 15 · 17 · 19 · 22 Spark Plug: 16 · 21

E10 · E11 · E12 · E14 · E16 · E18 · E20 · E22

- |                          |                                |
|--------------------------|--------------------------------|
| 5/16" · Screwdriver Bits | T40 · T45 · T50 · T55 · T60    |
| PH3 · PH4                | HX7 · HX8 · HX10 · HX12 · HX14 |
| PZ3 · PZ4                | 8 · 10 · 12                    |

72 Teeth Ratchet Handle 1/4" & 1/2"

Universal Joint 1/4" & 1/2"

Extensions 1/4" & 1/2": 50 & 75 - 125 & 250 mm

Spinner Handle 1/4"

Sliding "T" Handle 1/4"

3-Way Spinner Handle 1/2" 3/8" 1/2"

Square Drive Bit Holder 1/2" 5/16" 1/2"

Hex Key Wrenches 1,5 · 2 · 2,5



385 x 274 x 88 mm

Ref

▶ **500-026** ~~518,33 €~~ **274,41 €** ▶

# SOCKETS

## SOCKET & RATCHET HANDLE SETS

**151** PIECES

1/4", 3/8" & 1/2" HEXAGONAL SOCKETS



- ▶ 4 · 4,5 · 5 · 5,5 · 6 · 7 · 8 · 9 · 10 · 11 · 12 · 13 · 14  
Long Series: 4 · 5 · 6 · 7 · 8 · 9 · 10
- ▶ T4 · T5 · T6 · T7 · T8

- Socket Bits T8 · T9 · T10 · T15 · T20 · T25 · T27 · T30
- PH0 · PH1 · PH2 HX3 · HX4 · HX5 · HX6
- PZ0 · PZ1 · PZ2 4 · 5,5 · 6,5 · 7
- TS8 · TS9 · TS10 · TS15 · TS20 · TS25 · TS27 · TS30

- ▶ 10 · 11 · 12 · 13 · 14 · 15 · 16 · 17 · 18 · 19 Spark Plug: 18  
Long Series: 10 · 11 · 12 · 13 · 14 · 15
- ▶ T10 · T11 · T12 · T14 · T16 · T18

- ▶ 10 · 11 · 12 · 13 · 14 · 15 · 16 · 17 · 18 · 19 · 20 · 21 · 22 · 24 · 27 · 30 · 32  
Long Series: 16 · 17 · 18 · 19 · 22 Spark Plug: 16 · 21
- ▶ T20 · T24

- 5/16" Screwdriver Bits T40 · T45 · T50 · T55 · T60 · T70
- PH3 · PH4 HX7 · HX8 · HX10 · HX12 · HX14
- PZ3 · PZ4 8 · 10 · 12
- TS40 · TS45 · TS50 · TS55 · TS60 · TS70

- 72 Teeth Ratchet Handle 1/4", 3/8" & 1/2"
- Universal Joint 1/4", 3/8" & 1/2"
- Extensions 1/4", 3/8" & 1/2": 50 & 100 - 125 - 125 & 250
- Spinner Handle 1/4"
- Sliding "T" Handle 1/4"
- 3-Way Adapter 1/2" 3/8" < 1/2"
- Square Drive Bit Holder 1/2" & 3/8" 5/16" < 1/2" / 3/8"
- Hex Key Wrenches 1,27 · 1,5 · 2 · 2,5 · 3 · 4 · 5 1/2"



Ref 500-027 ~~715,25 €~~ **378,66 €** ▶ 435 x 305 x 95 mm

## CYLINDRICAL BENCH VICE

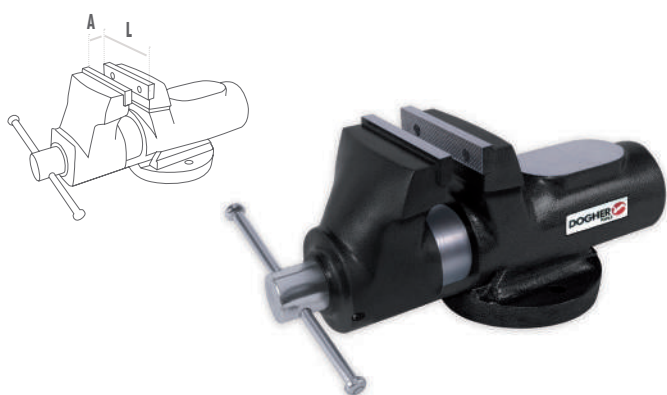

L mm	A mm	Kg	Ref	Price
▶ 100	105	13	925-100	<del>296,57 €</del> <b>174,45 €</b>
125	130	22	925-125	<del>408,35 €</del> <b>240,20 €</b>
150	155	32	925-150	<del>583,07 €</del> <b>342,98 €</b> ▶

## SQUARE GUIDED BENCH VICE

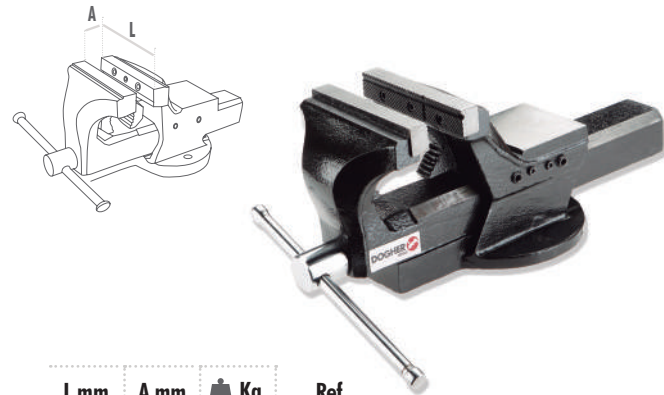

L mm	A mm	Kg	Ref	Price
▶ 100	105	7,5	926-100	<del>198,32 €</del> <b>116,66 €</b>
125	130	12	926-125	<del>221,00 €</del> <b>130,00 €</b>
150	155	17	926-150	<del>319,07 €</del> <b>187,69 €</b>
175	175	26	926-175	<del>505,31 €</del> <b>297,24 €</b> ▶



# KEY WRENCH

## SETS



- Thanks to the special ProFIX design the key wrench holds perfectly the screw allowing to work with only one hand.
- New ProFIX design provides a larger contact surface that enables to work even with damaged screws.

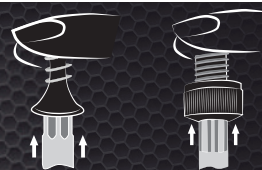

### 9 KEY WRENCH

#### HEX

1,5 · 2 · 2,5 · 3 · 4 · 5 · 6 · 8 · 10 mm



CrV



NEW

Ref 602-109

~~29,90 €~~ 17,59 €

### 9 KEY WRENCH

#### TORX

T8 · T9 · T10 · T15 · T20  
T25 · T27 · T30 · T40



CrV



NEW

Ref 608-109

~~35,34 €~~ 20,79 €

# KEY WRENCH

## SETS

### 9 KEY WRENCH

#### TORX

T10 · T15 · T20 · T25  
T27 · T30 · T40 · T45 · T50

CrV



Ref 606-009

~~23,71 €~~ 13,94 €

Ref 608-009

~~34,86 €~~ 20,51 €

Extra-Long Series

### 9 KEY WRENCH

#### TORX TAMPER

TS10 · TS15 · TS20 · TS25  
TS27 · TS30 · TS40 · TS45 · TS50

CrV



Ref 609-009

~~28,78 €~~ 16,93 €

Ref 611-009

~~40,71 €~~ 23,94 €

Extra-Long Series

### 9 KEY WRENCH

#### HEX

1,5 · 2 · 2,5 · 3  
4 · 5 · 6 · 8 · 10 mm

CrV



Ref 600-009

~~11,88 €~~ 6,81 €

Ref 602-009

~~17,28 €~~ 10,16 €

Extra-Long Series

### 9 KEY WRENCH

#### BALL NOSE HEX

1,5 · 2 · 2,5 · 3  
4 · 5 · 6 · 8 · 10 mm

CrV



Ref 603-009

~~15,91 €~~ 9,36 €

Extra-Long Series



Ref 605-009

~~23,60 €~~ 13,88 €



S2

Ref 605-069

~~27,69 €~~ 16,29 €



CrV

OX

Ref 607-079

~~23,15 €~~ 13,62 €

### 15 KEY WRENCH

#### BALL NOSE HEX

1,27 · 1,5 · 2 · 2,5 · 3  
3,5 · 4 · 4,5 · 5 · 5,5  
6 · 7 · 8 · 9 · 10 mm

CrV



Ref 605-089

~~39,88 €~~ 23,46 €

## T-HANDLES



- Ergonomic Handle
- Anti-Slip
- Bimaterial
- S2 Blade

Round Hex  
• 30° Until tightening tilt

S2

Ø	L mm	Ref	<del>Price</del>	Price
▶ 1,5	80	617-01,5	<del>6,94 €</del>	4,08 €
2,0	90	617-02	<del>6,94 €</del>	4,08 €
2,5	100	617-02,5	<del>7,06 €</del>	4,15 €
3,0	115	617-03	<del>7,15 €</del>	4,21 €
4,0	120	617-04	<del>8,55 €</del>	5,03 €
5,0	140	617-05	<del>9,29 €</del>	5,47 €
6,0	160	617-06	<del>9,90 €</del>	5,82 €
7,0	170	617-07	<del>13,52 €</del>	7,96 €
8,0	175	617-08	<del>12,99 €</del>	7,64 €
9,0	185	617-09	<del>15,02 €</del>	8,83 €
10,0	200	617-10	<del>16,11 €</del>	9,48 €
12,0	225	617-12	<del>27,48 €</del>	16,17 €

## 8 T-HANDLES DISPLAY

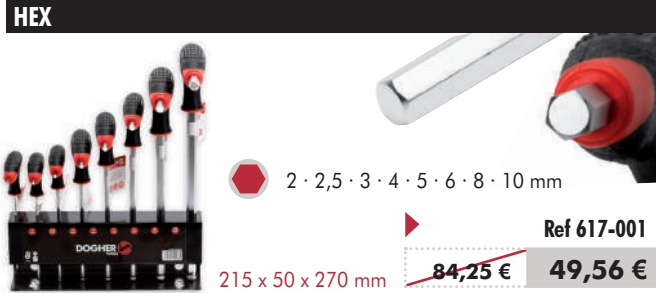

2 · 2,5 · 3 · 4 · 5 · 6 · 8 · 10 mm

Ref 617-001

215 x 50 x 270 mm ~~84,25 €~~ 49,56 €

## 8 T-HANDLES DISPLAY



2 · 2,5 · 3 · 4 · 5 · 6 · 8 · 10 mm

Ref 618-001

215 x 50 x 270 mm ~~84,25 €~~ 49,56 €

## LEVELS

### 3 VIAL SPIRIT LEVEL



AI

- 3 Vial 45° · 90° · 180°
- Shockproof Protection
- V-shape Base for Tube Surface

L mm	Ref	<del>Price</del>	Price
▶ 400	783-01-400	<del>33,31 €</del>	19,60 €
600	783-01-600	<del>38,08 €</del>	22,40 €
800	783-01-800	<del>44,20 €</del>	26,00 €
1000	783-01-1000	<del>52,19 €</del>	30,70 €
1200	783-01-1200	<del>58,83 €</del>	34,61 €

### 3 VIAL MAGNETIC SPIRIT LEVEL



AI

- 3 Vial 45° · 90° · 180°
- Magnetized

L mm	Ref	<del>Price</del>	Price
▶ 400	783-02-400	<del>18,96 €</del>	11,16 €
600	783-02-600	<del>24,62 €</del>	14,48 €
800	783-02-800	<del>26,98 €</del>	15,87 €
1000	783-02-1000	<del>33,36 €</del>	19,62 €
1200	783-02-1200	<del>42,36 €</del>	24,92 €
1800	783-02-1800	<del>63,36 €</del>	37,27 €

### 2 VIAL TRAPEZOID SPIRIT LEVEL



AI

L mm	Ref	<del>Price</del>	Price
▶ 400	784-01-400	<del>16,57 €</del>	9,75 €
600	784-01-600	<del>21,53 €</del>	12,67 €

- 2 Vial 90° · 180°

### 2 VIAL TORPEDO LEVEL



L mm	Ref	<del>Price</del>	Price
▶ 250	785-001	<del>20,95 €</del>	9,86 €

- 2 Vial 90° · 180°
- Shockproof Protection

# PROFESSIONALS MEASURING TAPES

- Metal Metric Tape
- Manual Lock Button
- Rubber Impact Protection
- Safety Strap included

## MEASURING TAPE 3 METERS DOUBLE FACE



Ref 771-03  
~~7,36 €~~ 4,33 €

## MEASURING TAPE 5 METERS DOUBLE FACE



Ref 771-05  
~~10,96 €~~ 6,45 €

## CLASSIC MEASURING TAPE 3 METERS METRIC AND INCH SCALE



Ref 772-03  
~~5,51 €~~ 3,24 €

## CLASSIC MEASURING TAPE 5 METERS METRIC AND INCH SCALE



Ref 772-05  
~~7,65 €~~ 4,50 €

## MEASURING TAPE 3 METERS



Ref 778-03  
~~4,46 €~~ 2,63 €

## MEASURING TAPE 5 METERS



Ref 778-05  
~~6,04 €~~ 3,55 €

## DIGITAL CALIPER

0,01 mm

Manual Manual

Instruction Manual Included  
mm & Inches Measures



mm Ref  
▶ 0 ~ 150 797-150 ~~66,81 €~~ 39,30 € ▶

## LASER DISTANCE METER



- Precision +2 mm
- Extendable Pintail for Corner Measuring

- Area and Volume
- Indirect Measuring
- Countdown Measuring
- Addition & Subtraction
- 20 Memories
- Measurement Unit  
Stake-out



- Includes:
- Carrying Case
  - Distance Meter
  - Silica-gel Protector
  - Engineering Pencil
  - AA Batteries
  - Safety Strap
  - Instruction Manual & Certificate

Ref 781-70  
~~288,90 €~~ 169,94 €

## DIGITAL CLAMP METER

CAT II 750V ~ 1000A ~ MAX



- Measures AC current, AC & DC, Voltage & resistance.
- Overload protection.
- Data-hold function.
- Audible continuity.
- Low battery indication.
- LCD display.
- Includes 10A test leads & soft case.
- Requires 1 x 9V battery.
- IEC 61010
- Pollution Grade II



Ref 795-001  
~~38,87 €~~ 22,86 €

## DIGITAL MULTIMETER

1000V ~ 750V ~



- Measures AC current, AC & DC Voltage & resistance.
- Checks continuity diodes & NPN/PNP transistors.
- Supplied with test leads.
- LCD display.
- Requires 9V battery (Not supplied).
- IEC 61010
- Pollution Grade II



Ref 795-002  
~~34,44 €~~ 20,26 €

## VOLTAGE TESTER



CAT II 600V  
V ~ 150V · 300V · 500V  
V ~ 110V · 220V · 380V

- 900 mm wire.
- Designed to be indoor use at temperature 5°C to 40°C.
- Altitude up to 2.000 m.
- IEC 61010
- Pollution Grade II



Ref 795-003  
~~14,12 €~~ 8,31 €

# PERCUSSION HAMMERS

## RUBBER HAMMERS

### DEAD BLOW HICKORY HANDLE

Ø mm	Ref	<del>Price</del>	Price
▶ 25	740-25	<del>21,72 €</del>	12,78 €
30	740-30	<del>27,05 €</del>	15,91 €
35	740-35	<del>31,04 €</del>	18,26 €
40	740-40	<del>48,21 €</del>	28,36 €
50	740-50	<del>54,17 €</del>	31,87 € ▶

· Spare head

UPE



## RUBBER HAMMERS

### HICKORY HANDLE

Ø mm	Ref	<del>Price</del>	Price
▶ 25	7331-25	<del>19,55 €</del>	11,50 €
30	7331-30	<del>24,34 €</del>	14,32 €
35	7331-35	<del>27,94 €</del>	16,43 €
40	7331-40	<del>40,02 €</del>	23,54 €
50	7331-50	<del>48,76 €</del>	28,68 € ▶

· Spare head

UPE

NEW



## RUBBER HAMMERS

### DEAD BLOW METAL HANDLE

Ø mm	Ref	<del>Price</del>	Price
▶ 35	7310-35	<del>36,50 €</del>	21,47 €
40	7310-40	<del>50,16 €</del>	29,51 €
50	7310-50	<del>58,92 €</del>	34,66 € ▶

· Spare head

PU



## RUBBER HAMMER

### FIBERGLASS HANDLE

Ø mm	Ref	<del>Price</del>	Price
▶ 35	742-35	<del>27,70 €</del>	16,29 € ▶

PU



## PU HAMMER

### HICKORY HANDLE

Ø mm	Ref	<del>Price</del>	Price
▶ 22	7332-22	<del>17,59 €</del>	10,35 €
28	7332-28	<del>21,91 €</del>	12,89 €
35	7332-35	<del>25,14 €</del>	14,79 €
45	7332-45	<del>42,25 €</del>	24,85 €
60	7332-60	<del>62,36 €</del>	36,68 € ▶

PU



NEW

## PU

### SPARE HEAD

Ø mm	Ref	<del>Price</del>	Price
▶ 22	7333-22	<del>4,98 €</del>	2,93 €
28	7333-28	<del>6,25 €</del>	3,68 €
35	7333-35	<del>7,52 €</del>	4,42 €
45	7333-45	<del>8,50 €</del>	5,00 €
60	7333-60	<del>12,25 €</del>	7,21 € ▶

PU



NEW

## PRO HIT HAMMER

### HICKORY HANDLE

Ø mm	Ref	<del>Price</del>	Price	Material
▶ 30	7420-30	<del>26,36 €</del>	15,51 €	PU
40	7420-40	<del>38,25 €</del>	22,50 €	PU
50	7420-50	<del>52,36 €</del>	30,80 €	UPE
60	7420-60	<del>86,36 €</del>	50,80 €	UPE
80	7420-80	<del>125,25 €</del>	73,68 €	UPE



NEW

## PRO HIT HAMMER

### SPARE HEAD

Ø mm	Ref	<del>Price</del>	Price	Material
▶ 30	7421-30	<del>5,36 €</del>	3,15 €	PU
40	7421-40	<del>8,25 €</del>	4,85 €	PU
50	7421-50	<del>12,21 €</del>	7,18 €	UPE
60	7421-60	<del>19,36 €</del>	11,39 €	UPE
80	7421-80	<del>26,36 €</del>	15,51 €	UPE



PU



UPE

NEW

# PERCUSSION

## HAMMERS

### BALL PEN

#### HICKORY HANDLE

	g	A mm	L mm	Ref	<del>Price</del>	Price
▶ B	340	28	315	700-340	<del>13,43 €</del>	7,90 €
C	455	30	350	700-455	<del>16,23 €</del>	9,55 €
D	560	32	350	700-560	<del>18,76 €</del>	11,03 €
E	680	34	360	700-680	<del>20,79 €</del>	12,23 €
F	910	38	390	700-910	<del>22,50 €</del>	13,24 €
G	1130	40	420	700-1130	<del>24,97 €</del>	14,69 €
H	1360	40	420	700-1360	<del>26,79 €</del>	15,76 € ▶



### BALL PEN

#### FIBERGLASS HANDLE

	g	A mm	L mm	Ref	<del>Price</del>	Price
▶ C	455	30	310	701-455	<del>22,31 €</del>	13,12 €
D	560	32	310	701-560	<del>24,34 €</del>	14,32 €
E	680	34	330	701-680	<del>26,57 €</del>	15,63 €
F	910	38	365	701-910	<del>31,19 €</del>	18,35 €
H	1360	40	400	701-1360	<del>41,21 €</del>	24,24 € ▶



### BIG HEAD SLEDGE HAMMERS

#### FIBERGLASS HANDLE

	g	L mm	Ref	<del>Price</del>	Price
▶	3000	900	713-3000	<del>53,37 €</del>	28,26 €
	4000	900	713-4000	<del>67,62 €</del>	33,81 €
	5000	900	713-5000	<del>76,07 €</del>	38,04 € ▶



### SHUTTERING HAMMERS

#### FIBERGLASS HANDLE

	g	L mm	Ref	<del>Price</del>	Price
▶	700	500	711-700	<del>28,69 €</del>	16,88 € ▶



### SLATE HAMMER



	g	L mm	Ref	<del>Price</del>	Price
▶	400	315	715-010	<del>17,55 €</del>	10,32 € ▶

### SPANISH STONE HAMMERS

#### FIBERGLASS HANDLE

	g	L mm	Ref	<del>Price</del>	Price
▶	1000	260	705-1000	<del>23,39 €</del>	13,76 €
	1250	260	705-1250	<del>26,02 €</del>	15,31 € ▶



## PERCUSSION

### HAMMERS

#### HAMMER SHOVEL PICKS HICKORY HANDLE



g	L mm	Ref	<del>25,97 €</del>	15,27 € ▶
700	330	714-700		

#### WELDER'S PICK TUBULAR HANDLE



g	L mm	Ref	<del>16,92 €</del>	9,95 € ▶
500	260	715-001		

#### AXE SHOVEL PICK FIBERGLASS HANDLE



g	L mm	Ref	<del>25,91 €</del>	15,24 € ▶
550	370	717-550		
650	370	717-650	<del>29,30 €</del>	17,23 € ▶

#### SPIKE SHOVEL PICK FIBERGLASS HANDLE



g	L mm	Ref	<del>29,48 €</del>	17,34 € ▶
400	330	719-400		
650	330	719-650	<del>32,39 €</del>	19,05 € ▶

#### AXE HICKORY HANDLE



g	L mm	Ref	<del>23,49 €</del>	13,82 € ▶
500	450	724-500		
700	450	724-700	<del>25,42 €</del>	14,95 € ▶
1000	680	724-1000	<del>34,61 €</del>	20,36 € ▶

#### SLEDGE HAMMER FIBERGLASS HANDLE



g	L mm	Ref	<del>68,38 €</del>	40,22 € ▶
3000	950	726-3000		

#### RUBBER HAMMERS HICKORY HANDLE



g	Ø mm	L mm	Ref	<del>11,11 €</del>	6,53 € ▶
685	60	330	736-685		
920	65	330	736-920	<del>13,51 €</del>	7,95 € ▶

#### SPLITTING WEDGE



g	Ref	<del>31,48 €</del>	18,52 € ▶
2000	726-020		
3000	726-030	<del>41,06 €</del>	24,15 € ▶

## DRIFT PUNCH SET

### SHEATHED DRIFT PUNCH SET PATENTED "TOPGRIP" HANDLE

6

Pcs

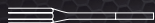

Ø 2 · 3 · 4 · 5 · 6 · 8 mm

Ref 7445-001

~~56,00 €~~ 32,94 €

Hand guard patented  
TOPGRIP  
Norm NFE 71211  
DIN 6450C

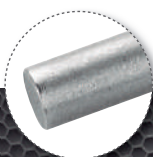

### DRIFT PUNCH SET

9

Pcs



Ø 2 · 3 · 4 · 6  
3 · 4 · 5 · 6 · 2 · 4 · 3 · 6 mm

Ref 7443-001

~~108,23 €~~ 63,66 €



### DRIFT PUNCH SET OCTOGONAL SHAPED BODY

6

Pcs



Ø 3 · 4 · 5 · 6 · 8 · 10 mm

Ref 7446-003

~~46,11 €~~ 27,12 €



### SHEATED DRIFT PUNCH "SHOCKGRIP" PATENTED HANDLE

Drift Punches manufactured to resist high impacts.  
Patented Ergonomic ShockGrip Handle. Avoid Injuries.

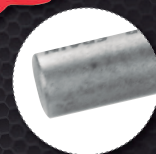

### SHEATED DRIFT PUNCH SET "SHOCKGRIP" PATENTED HANDLE

5

Pcs



Ø 3 · 4 · 5 · 6 · 8 mm

Ref 7447-001

~~60,90 €~~ 35,82 €



### SHEATED DRIFT PUNCH SET "SHOCKGRIP" PATENTED HANDLE LONG SERIES

4

Pcs



Ø 10 · 12 · 14 · 16 mm

Ref 7447L-001

~~118,64 €~~ 69,79 €



### AUTOMATIC CENTRE PUNCH

CrV

143  
mm

36  
kgs



Maximum load: 36 kgs.

Ref 750-013

~~33,60 €~~ 19,76 €

### DOUBLE ENDED STEEL SCRIBER



Ref 796-003

~~5,69 €~~ 3,35 €

• Tungsten Carbide Tip

### RETRACTABLE PEN TYPE SCRIBER



Ref 796-006

~~18,54 €~~ 10,91 €

• Tungsten Carbide Tip  
• Includes 2 tips: 32mm (Tungsten carbide) y 89 mm (Pencil Lead)



## MARKING PUNCHES SET

### 100 INTERCHANGEABLE MARKING PUNCHES SET

Kit includes :  
 52 individual pcs of letters A thru Z (Two each A~Z)  
 36 individual pcs of numbers 0 thru 8 (Four each 0~8, the 6 is used as 9)  
 1 pc of "&"  
 2 pcs of "/"  
 2 pcs of "-"  
 6 pcs of blank space  
 The holder can accommodate 9 pieces.



\* Hardness 58-60HRc

L mm	L"	Ref	<del>Price</del>	Price
▶ 3,00	1/8	763-001	<del>724,57 €</del>	426,22 €
5,00	3/16	763-002	<del>724,57 €</del>	426,22 €

### 9 NUMERICAL MARKING PUNCHES SET

L mm	L"	Ref	<del>Price</del>	Price
▶ 2,00	5/64	763-020	<del>10,21 €</del>	6,01 €
3,00	1/8	763-030	<del>10,75 €</del>	6,32 €
4,00	5/32	763-040	<del>11,30 €</del>	6,65 €
5,00	3/16	763-050	<del>12,43 €</del>	7,31 €
6,00	1/4	763-060	<del>13,84 €</del>	8,14 €
7,00	9/32	763-070	<del>19,06 €</del>	11,21 €
8,00	5/16	763-080	<del>19,06 €</del>	11,21 €
10,00	3/8	763-100	<del>24,84 €</del>	14,61 €
12,00	1/2	763-120	<del>36,30 €</del>	21,35 €



58-62 Hrc  
 · DIN 1451- DIN 7353

### 27 ALPHABETIC MARKING PUNCHES SET

L mm	L"	Ref	<del>Price</del>	Price
▶ 2,00	5/64	763-202	<del>30,63 €</del>	18,02 €
3,00	1/8	763-203	<del>31,62 €</del>	18,60 €
4,00	5/32	763-204	<del>33,85 €</del>	19,91 €
5,00	3/16	763-205	<del>36,69 €</del>	21,58 €
6,00	1/4	763-206	<del>41,40 €</del>	24,36 €
7,00	9/32	763-207	<del>57,14 €</del>	33,61 €
8,00	5/16	763-208	<del>57,14 €</del>	33,61 €
10,00	3/8	763-210	<del>74,50 €</del>	43,82 €
12,00	1/2	763-212	<del>98,36 €</del>	57,86 €



58-62 Hrc  
 · DIN 1451- DIN 7353

## BI-METAL HACKSAW BLADES



840-050

BI

840-059

L mm	A mm	B mm	Z	Ref	<del>Price</del>	Price
300	13	0,65	24	840-050	<del>198,79 €</del>	116,94 €
300	13	0,65	24	840-059	<del>227,63 €</del>	133,90 €

### PRUNING BOW SAW



L mm	Ref	<del>Price</del>	Price
▶ 450	848-450	<del>8,25 €</del>	4,85 €
525	848-525	<del>8,67 €</del>	5,10 €
600	848-600	<del>9,12 €</del>	5,36 €
750	848-750	<del>9,91 €</del>	5,83 €
800	848-800	<del>10,37 €</del>	6,10 €
900	848-900	<del>11,18 €</del>	6,58 €

Includes Blade

### PROFESSIONAL HAND SAW



L mm	Ref	<del>Price</del>	Price
▶ 300	836-300	<del>18,40 €</del>	10,82 €
350	836-350	<del>19,08 €</del>	11,22 €
400	836-400	<del>19,23 €</del>	11,31 €
450	836-450	<del>23,17 €</del>	13,63 €
500	836-500	<del>26,55 €</del>	15,62 €
550	836-550	<del>28,62 €</del>	16,84 €



### PROFESSIONAL HACKSAW FRAME

Includes Bi-metal Blade  
 Aluminium Shank  
 10 Blades Store  
 45° - 90° · Blade Clamping



L mm	Ref	<del>Price</del>	Price
▶ 300	840-002	<del>35,52 €</del>	20,90 €

### PROFESSIONAL FOLDING SAW



L mm	Ref	<del>Price</del>	Price
▶ 150	843-001	<del>23,27 €</del>	13,69 €

· Plasterboard & wood

**PROFESSIONAL  
BOLT CUTTER**



L mm	● mm	Ref	<del>Price</del>	Price
▶ 200	0,5~2	292-200	<del>39,19 €</del>	21,90 €
300	1~3,5	292-300	<del>51,41 €</del>	28,73 €
320	2~6,5	292-320	<del>59,80 €</del>	33,42 €
470	4~8	292-470	<del>79,78 €</del>	44,58 €
630	5~11	292-630	<del>100,07 €</del>	55,92 €
750	6~13	292-750	<del>136,62 €</del>	76,35 €
900	8~17	292-900	<del>186,43 €</del>	104,18 €
1050	9~19	292-1050	<del>232,70 €</del>	130,04 € ▶

**DOUBLE LEVERAGE  
DIAGONAL CUTTING PLIER**



**64 HRC**

- Spring Joint. Automatic opening.
- Multiplies the Cutting Force with Less Effort



Cutting Capacity		Ref 90 max.
▶ Piano Wire	3,8 mm	▶
Steel Wire	6 mm	
▶		Ref 207-225
<del>44,06 €</del>		25,92 €

**TELESCOPING INSPECTION  
MIRROR**



▶		Ref 930-001
<del>14,26 €</del>		8,39 €
L min-max. 240-930 Ø 56,5 mm		

**CAULKING  
GUNS**

**FOAM GUN  
PRO**

**167  
mm**

**2 mm**

- The inside and outside metal are teflon coated
- Ergonomic bimaterial handle
- Aluminum gun body with steel barrel and needle
- Aluminum adapter for fast & firm
- Brass gasket nut and aluminium regulation wheel
- Easy to clean, heavy duty use

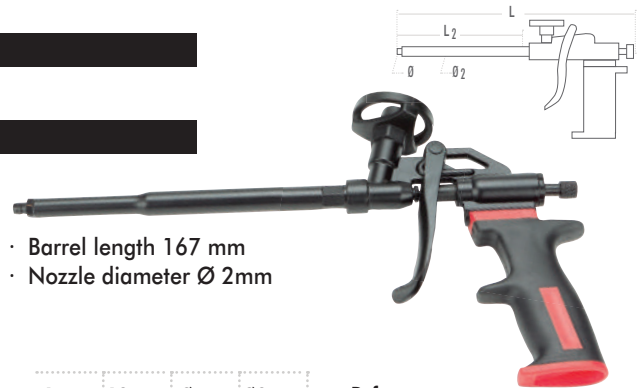

- Barrel length 167 mm
- Nozzle diameter Ø 2mm

L mm	L2 mm	Ø mm	Ø2 mm	Ref	<del>Price</del>	Price
▶ 325	190	11	14	914-001	<del>36,71 €</del>	21,59 € ▶

**CAULKING GUN  
ALUMINIUM HANDLE**

**Ø mm  
50**



L mm	Ø mm	Ref	<del>Price</del>	Price
▶ 225	50	912-225	<del>18,78 €</del>	11,05 € ▶
• 50% Less Effort				

**MORTAR CAULKING GUN  
ALUMINIUM BODY**

**Ø mm  
50**



L mm	Ø mm	Ref	<del>Price</del>	Price
▶ 375	50	913-375	<del>21,67 €</del>	12,75 € ▶
• Capacity: 600 ml				

## DOUBLE SOCKET SCAFFOLDING WRENCH

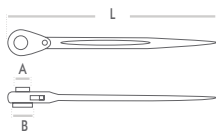

CrV	A mm	B mm	L mm	Ref	Price
	19	22	320	892-19-22	<del>51,56 €</del> 30,33 €

## PUTTY KNIFE BIMATERIAL HANDLE

Inox

C mm	Ref	Price
30	879-30	<del>5,33 €</del> 3,13 €
40	879-40	<del>5,38 €</del> 3,16 €
50	879-50	<del>5,64 €</del> 3,32 €
60	879-60	<del>5,90 €</del> 3,47 €
70	879-70	<del>6,31 €</del> 3,71 €
80	879-80	<del>6,76 €</del> 3,98 €
100	879-100	<del>7,55 €</del> 4,44 €
120	879-120	<del>8,68 €</del> 5,10 €
150	879-150	<del>10,41 €</del> 6,12 €



## BUCKET TROWEL BIMATERIAL HANDLE



A	C mm	L mm	Ref	Price
	115	180	883-02-180	<del>13,74 €</del> 8,08 €

## MADRID MODEL TROWEL BIMATERIAL HANDLE



F-H	C mm	L mm	Ref	Price
	98	178	883-04-180	<del>12,50 €</del> 7,36 €

## CATALAN MODEL TROWEL BIMATERIAL HANDLE



B	C mm	L mm	Ref	Price
	120	170	883-06-170	<del>13,18 €</del> 7,75 €

## PLASTERING TROWEL WOODEN HANDLE

Inox

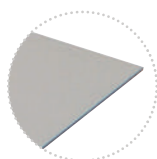
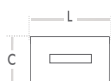

1-150	C mm	L mm	Ref	Price
	300		886-002	<del>13,37 €</del> 7,86 €

## ADHESIVE TROWEL WOODEN HANDLE

Inox

6x6 mm



6-120	C mm	L mm	Ref	Price
	280		886-005	<del>14,66 €</del> 8,62 €

## ADHESIVE TROWEL WOODEN HANDLE

Inox

8x8 mm

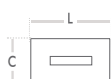

8-120	C mm	L mm	Ref	Price
	280		886-006	<del>14,23 €</del> 8,37 €

## ADHESIVE TROWEL WOODEN HANDLE

Inox

10x10 mm



10-120	C mm	L mm	Ref	Price
	280		886-007	<del>15,04 €</del> 8,85 €

**LOW DENSITY  
SPONGE FLOAT**

- Low Density Foam
- 30mm Thick Sponge Base

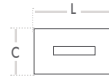

C mm	L mm	Ref		
▶ 140	280	886-018	<del>7,64 €</del>	<b>4,49 €</b>



**FOAM RUBBER  
SPONGE FLOAT**

- 20mm Thick Sponge Base
- Polystyrene Handle and Base
- Diameter of holes bigger than Ref.886-017

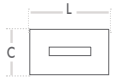
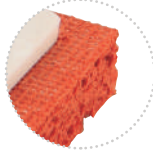

C mm	L mm	Ref		
▶ 140	280	886-016	<del>9,17 €</del>	<b>5,39 €</b>

**HIGH DENSITY FOAM RUBBER  
SPONGE FLOAT**

- 20mm Thick Sponge Base
- Polystyrene Handle and Base
- Diameter of holes smaller than Ref.886-016

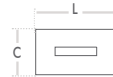

C mm	L mm	Ref		
▶ 140	280	886-017	<del>9,38 €</del>	<b>5,52 €</b>

**ROLLING HEAD  
PRY BAR**



L mm		Ref		
▶ 303	35	888-36-304	<del>23,36 €</del>	<b>13,74 €</b>
402	49	888-44-406	<del>31,25 €</del>	<b>18,38 €</b>
500	54	888-58-503	<del>38,22 €</del>	<b>22,48 €</b>

NEW

**WRECKING  
BAR**



L mm	mm	Ref		
▶ 300	14	884-04-300	<del>11,01 €</del>	<b>6,48 €</b>
500	20	884-05-500	<del>16,28 €</del>	<b>9,58 €</b>
600	20	884-05-600	<del>20,93 €</del>	<b>12,31 €</b>
700	20	884-05-700	<del>23,79 €</del>	<b>13,99 €</b>
800	22	884-05-800	<del>26,40 €</del>	<b>15,53 €</b>
900	22	884-05-900	<del>30,81 €</del>	<b>18,12 €</b>
1000	22	884-05-1000	<del>32,78 €</del>	<b>19,28 €</b>
1200	22	884-05-1200	<del>36,95 €</del>	<b>21,74 €</b>

**D-HANDLE  
PLASTIC SHOVEL**



A mm	B mm	L mm	Ref	
▶ 460	360	1020	871-050	<del>32,25 €</del> <b>18,97 €</b>

NEW

# HANDLE XL 1300mm

**NEW**

- Head made of anti wear steel
- Anti-rusty finish
- High resistant wooden handle

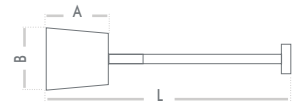

## T HANDLE POINTED SHOVEL

**NEW**



A mm	B mm	L mm	Ref
▶ 340	280	1300	870-015
<del>27,01 €</del> <b>15,89 €</b> ▶			

## T HANDLE SQUARE SHOVEL

**NEW**



A mm	B mm	L mm	Ref
▶ 340	280	1300	870-025
<del>27,01 €</del> <b>15,89 €</b> ▶			

## RING HANDLE POINTED SHOVEL

**NEW**



A mm	B mm	L mm	Ref
▶ 340	280	1300	870-035
<del>28,36 €</del> <b>16,68 €</b> ▶			

## RING HANDLE SQUARE SHOVEL

**NEW**



A mm	B mm	L mm	Ref
▶ 340	280	1300	870-045
<del>28,36 €</del> <b>16,68 €</b> ▶			

## PRUNERS



### HEAVY DUTY PRUNER



- High resistance CK67 upper and lower blade with **Teflon** coating.
- Aluminium alloy handle with PVC dipping
- Security lock.

◀	◉	L mm	Ref	▶
▶	15	210	960-003	<del>24,15 €</del> 14,21 € ▶

### HEAVY DUTY ALUMINIUM BYPASS LOPPER



◉	L mm	Ref	▶
▶	40	695	961-002 <del>49,35 €</del> 29,03 € ▶

### ALUMINIUM BYPASS LOPPER



◉	L mm	Ref	▶
▶	30	660	961-001 <del>48,33 €</del> 28,43 € ▶

### WAVE BLADE HEDGE SHEARS

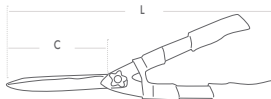

L mm	C mm	Ref	▶
▶	575	210	961-003 <del>48,50 €</del> 28,53 € ▶



### GARLIC AND ONIONS HARVEST SHEAR



◉	L mm	Ref	▶
▶	20	180	963-002 <del>13,45 €</del> 7,91 € ▶
L mm	L"	Ref	▶
▶	190	8	963-004 <del>11,12 €</del> 6,54 € ▶
L mm	L"	Ref	▶
▶	200	8	963-001 <del>14,12 €</del> 8,31 € ▶

NEW

### HARVEST SHEAR



L mm	L"	Ref	▶
▶	180	7	963-005 <del>9,99 €</del> 5,88 € ▶
L mm	L"	Ref	▶
▶	180	7	963-006 <del>11,12 €</del> 6,54 € ▶
L mm	L"	Ref	▶
▶	180	7	963-007 <del>9,99 €</del> 5,88 € ▶

NEW

**THREAD RESTORING**

**FILE**

- For external and internal threads
- Metric pitches: 0,80-1,00-1,25-1,50-1,75-2,00-2,50-3,00



CrV ▶ Ref 817-010  
~~61,71 €~~ **36,30 €**

**BI-MATERIAL HANDLE  
POINTED FLAT FILE SECOND CUT**

**NEW**

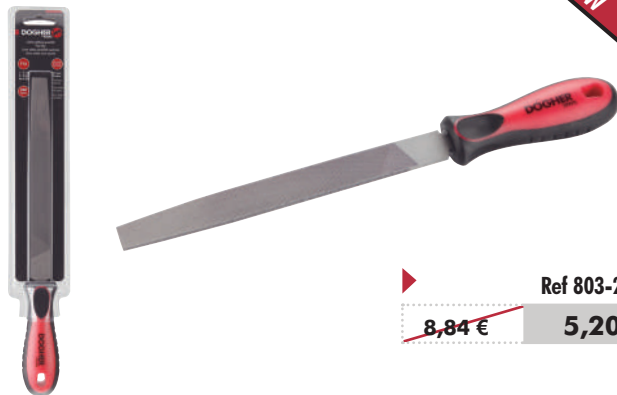

▶ Ref 803-200  
~~8,84 €~~ **5,20 €**

**BI-MATERIAL HANDLE**

**3 FILE SET**

**3**  
Pcs

**T20**

**200**  
mm



- 200mm
- 200mm
- 200mm
- 2nd Cut



Includes Canvas Wallet

▶ Ref 815-001  
~~31,19 €~~ **18,34 €**

**10 DIAMOND PRECISION**

**FILES SET**



- x2 140mm
- x2 140mm
- 140mm
- 140mm
- 140mm
- 140mm

▶ Ref 816-001  
~~236,36 €~~ **139,03 €**

**MULTIPLE 2 & 3 ARMS**

**GEAR PULLER**

CrV

**100**  
mm

**200**  
mm

**250**  
mm



905-001



905-002

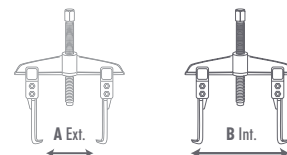

L mm	A min-A max	B min-B max	Ref
▶ 100-250	30-140	55-170	905-004 <del>358,16 €</del> <b>210,68 €</b> ▶

**SEPARATOR PULLER**

**TOOLS SET**

CrV

**30-50**  
mm

**50-75**  
mm



min-max ▶ Ref  
 ▶ 30-75 ▶ 905-005 ~~207,88 €~~ **122,28 €** ▶

## MAGNETIC HOLDER

8 UNITS

Ø 60 mm 10 Kg

PATENTADO  
PATENTED  
BREVETÉ  
PATENTEADO



NEW



Ref 075-030J

~~98,88 €~~ 58,16 €

Ref 075-030

~~12,36 €~~ 7,27 €

## RIVET GUN

### PROFESSIONAL RIVET GUN



Ref 918-010

~~36,84 €~~ 21,67 €

- Replaceable nozzle head
- 4 heads are included ø 2,4-3,2-4-4,8 mm.
- Spring loaded handle ejects rivets stem
- Comfortable anti slip handle

### AUTOMATIC RIVETER



4 in 1

Ref 918-012

~~32,12 €~~ 18,89 €

- Replaceable nozzle head
- 4 heads are included ø 2,4-3,2-4-4,8 mm.
- Spring loaded handle ejects rivets stem
- Comfortable anti slip handle

## DOUBLE HAND RIVETER WITH MULTI-SIZE HEAD

- Multi size head
- 4 sizes in the same head ø 3,2-4-4,8-6,4 mm
- Spring loaded handle ejects rivets stem
- Comfortable anti slip handle



Ref 919-016

~~67,98 €~~ 39,99 €

## INTERCHANGEABLE HEAD

4 in 1



- Multi size head for rivet gun 919-016 ø 3,2-4-4,8-6,4mm
- 4 rivet diameters in 1 head



Ref 918-6

## CHAIN OIL FILTER WRENCH



L mm	Ø mm	Ref
330	60-105	481-010
500	60-160	481-011

~~75,31 €~~ 32,12 €

~~86,61 €~~ 36,93 €





## LANYARDS

### STRING LANYARD WITH RING



Ref 1500-001  
~~11,25 €~~ 6,62 €

### SAFETY LANYARD FOR TOOLS

10 Kg

- Avoid accidental dropping of tools when work at height.
- High strength nylon straps with elastic core and triple seams on both ends for greater security.
- Fixed carabiners with Aluminium Twist lock system.

Nylon

min 770 mm

max 1.400 mm



Ref 1500-10  
~~58,25 €~~ 34,26 €

### SAFETY LANYARD FOR TOOLS

5 Kg

- Avoid accidental dropping of tools when work at height.
- High strength Nylon straps with elastic core.
- Rotating carabiners.
- Rope with safety ring Ref.1500-001 included.

Nylon

min 800 mm

max 1.400 mm



Ref 1510-05  
~~49,36 €~~ 29,04 €

### FLEXIBLE LANYARD WITH ROTATING CARABINERS

3 Kg

- Avoid accidental dropping of tools when work at height.
- Extensible rolled up PU wire with 1mm high strength stainless steel core.
- Rotating carabiners.

PU

min 640 mm

max 2.000 mm



Ref 1520-03  
~~21,22 €~~ 12,48 €

# INOX SERIE

## 5 DRAWER TOOL CABINET

Inox

Aisi 304

• Drawer Dim.:

565 x 410 x 61/140 mm

460 mm  
846 mm  
680 mm



Ref 20025-007

~~1,545,56 €~~ 1.113,71€

NEW

## SET ZIPPING

### 3 STAINLESS STEEL PLIERS



160 mm



180 mm



160 mm

Ref 20210-002

~~142,80 €~~ 102,90 €



## 6 SCREWDRIVERS

### INOX EN CAJA

Milled  
3 · 4 · 5 · 6

Ref 20330-001

PH1 · PH2

~~60,80 €~~ 43,81 €



## DOUBLE OPEN END WRENCH



## 6 COMBINATION WRENCHES

8 · 10 · 11 · 12 · 13 · 14

Ref 20451-016

~~85,75 €~~ 61,79 €



## 6 COMBINATION WRENCHES

8 · 10 · 11 · 12 · 13 · 14 · 17 · 19

Ref 20451-018

~~118,57 €~~ 85,44 €



## 5 COMBINATION WRENCHES

8 · 10 · 11 · 12 · 13

Ref 20451-035

~~68,99 €~~ 49,71 €



## 5 COMBINATION WRENCHES

8 · 10 · 11 · 12 · 13 · 14

Ref 20451-036

~~84,50 €~~ 60,89 €



## 5 COMBINATION WRENCHES

8 · 10 · 11 · 12 · 13 · 14 · 17 · 19

Ref 20451-038

~~123,86 €~~ 89,25 €



## SOCKET SETS

### 8 HEX SOCKETS 1/2"

8 · 10 · 11 · 12  
13 · 14 · 17 · 19



Ref 20531-051

~~221,18 €~~ 159,38 €

### 8 HEX SOCKETS 1/2" & RATCHET HANDLE

8 · 10 · 11 · 12  
13 · 14 · 17 · 19



Ref 20531-062

~~327,18 €~~ 235,76 €

**BOTTLE JACK**

**WELDED BOTTLE JACK**

**NEW**

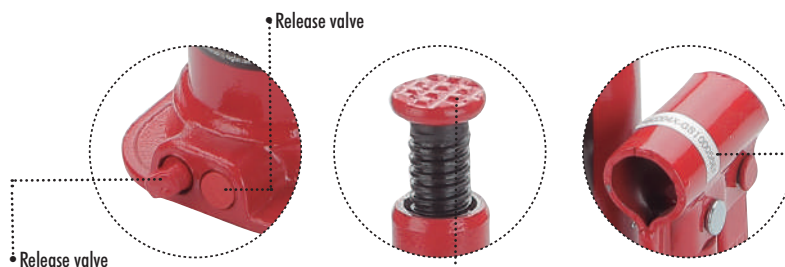

• Release valve

• Release valve

• Heat-treated knurled pad with screw adjustment for an increased versatility.

• Stick coupling.

• Made in high quality steel according to the highest standards of quality and durability

• La the paint is resistant to oil, grease and dirt for an easy cleaning.



Capacity	Min. Height	Elevation Height	Adjustable Height	Max. Height	N.W. kg.	Ref		
▶ 02 TON	168 mm	100 mm	48 mm	316 mm	2 kg	9000-02	<del>55,95 €</del>	<b>32,91 €</b>
05 TON	207 mm	127 mm	60 mm	404 mm	3,7 kg	9000-05	<del>75,31 €</del>	<b>44,30 €</b>
10 TON	222 mm	145 mm	80 mm	447 mm	4,7 kg	9000-10	<del>101,13 €</del>	<b>59,49 €</b> ▶



• Telescopic bar.

• Made in high quality steel according to the highest standards of quality and durability

• La the paint is resistant to oil, grease and dirt for an easy cleaning.

• Steel handle for an easier transport of the jack

• Telescopic bar



Capacity	Min. Height	Elevation Height	Adjustable Height	Max. Height	N.W. kg.	Ref		
▶ 15 TON	227 mm	150 mm	80 mm	457 mm	6,9 kg	9000-15	<del>129,11 €</del>	<b>75,95 €</b>
20 TON	225 mm	150 mm	60 mm	445 mm	8,8 kg	9000-20	<del>156,01 €</del>	<b>91,77 €</b>
32 TON	260 mm	160 mm	-	420 mm	17,8 kg	9000-32	<del>210,88 €</del>	<b>124,04 €</b> ▶

PROMOTION  
**2020**



**GOBOX**  
by DOGHER TOOLS

**DOGHER**  
Making Solutions  
® TOOLS



DOGHER TOOLS, S.A.  
Pol. Industrial Arriandi  
Tabernabbarri Nº5  
48215 Iurreta (Spain)  
Tel.: +34 946216145  
Fax: +34 946216147  
comercial@dogher.com  
export@dogher.com  
www.dogher.com



Promotion valid from 10/02/2020 to 30/12/2020